

Solenoid Controlled Pilot Operated Directional Valves

These valves are composed of a solenoid operated pilot valves and a pilot operated slave valve. When a solenoid is energised the pilot valve directs the flow to move the spool of the slave valve, thus changing the direction of flow in the hydraulic circuit.

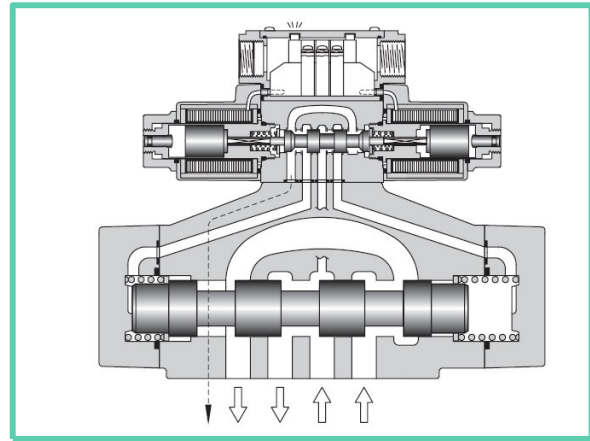
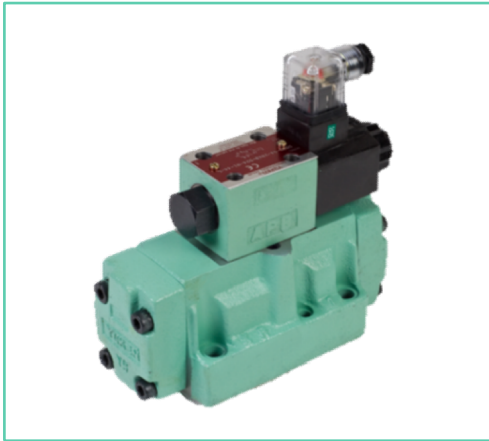

- **High Pressure High Flow**
High pressure [315 Kgf/cm²] along with high flow means compact system design.
- **Lower pressure Drop**
System energy saving increased as pressure drop of each valve has greatly reduced.

Graphic symbol

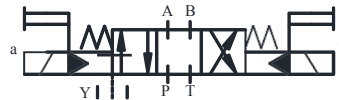

Specifications

Valve Type	Model Numbers	*1 Max. Flow L/min	Max. Operating Pressure Kgf/cm ²	Max. Pilot Pressure Kgf/cm ²	Min. *2 Required Pilot Pres. Kgf/cm ²	Max. T-Line Back Pressure Kgf/cm ²		Max. Changeover Frequency Cycles/min			Mass Kg
						Ext. Drain	Int. Drain	AC	DC	R	
Standard Type	(S)-DSHG-04-3C※-※-50	300	315	250	8	210	160	120	120	120	8.8
	(S)-DSHG-04-2N※-※-50										8.8
	(S)-DSHG-04-2B※-※-50										8.2
	(S)-DSHG-06-3C※-※-51	500	315	250	8	210	160	120	120	120	12.7
	(S)-DSHG-06-2N※-※-51										12.7
	(S)-DSHG-06-2B※-※-51										12.1
(S)-DSHG-06-3H※-※-51	13.5										
Shockless Type	(S)-DSHG-10-3C※-※-41	1100	315	250	10	210	160	120	120	100	45.3
	(S)-DSHG-10-2N※-※-41							100	100	100	45.3
	(S)-DSHG-10-2B※-※-41			60	60			50	44.7		
	(S)-DSHG-10-3H※-※-41			53.1							

* 1. Maximum flow indicates a ceiling flow. As the ceiling flow depends on the type of spool and operating condition, refer to the list of Spool Functions in pages 360 to 362 for details.

* 2. Pilot pressure of internal pilot drain models must always exceed tank line back pressure by the minimum required pilot pressure.

Expanded symbol

- DSHG-04

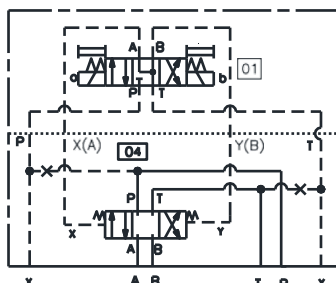

- DSHG-06, 10

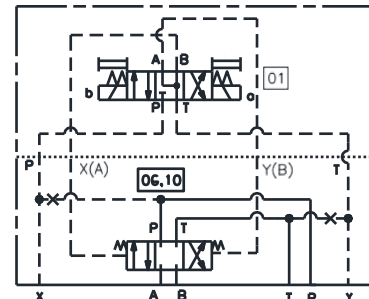

Solenoid Controlled Pilot Operated Directional Valves

DIRECTIONAL CONTROLS

Model Number Designation

F-	S-	DSH	G	-06	-2	B	2	A	-C2 *	-E	T	-R2 *	-D24	-N	-51	-L			
Special Seals **	Type	Series Number	Type of Mounting	Valve Size	Number of Valve Positions	Spool-Spring Arrangement	Spool Type	Special Two Position Valve	Models with Pilot Choke Valve	Pilot Connection	Drain Connection	Spool Control Modification (Omit if not required)	Coil Type	Type of Electrical Conduit Con.	Design Number	Mod. With Alternate Offset Sol.			
F: For Phosphate Ester Type Fluids	None: Standard Type	DSH: Solenoid Controlled Pilot Operated Directional Valve.	G: Sub-plate Mounting	04	3	C: Spring Centred	2,4, 40,60, 10,12 (3,5, 6,*17, 9,11)	---	C1: * With C1 Choke C2: * With C2 Choke	None: Internal Pilot	None: External Drain	R2: With Stroke Adjustment, Both Ends RA: With Stroke Adjustment Port "A" End RB: With Stroke Adjustment Port "B" End	AC: A100, A120, A200, A240 DC: D12, D24, D100 R: *3 (AC□DC) R110, R220	None: Terminal Box Type N0: Plug-in Type, but Without Connector N: Plug-in Connector Type N1: Plug-in Connector with indicator Light	50	---	L: (Omit if not Required)		
					2	N: No-Spring	2,4, 40,6, 60,9, 12 (3,7) *1	A *2 (Omit if not Required)										C1C2: * With C1&C2 Choke (Omit if not Required)	E: External Pilot
	S: Shockless Type				06	3	C: Spring Centred	2,4, 40,60, 10,12 (3,5, 6,*17, 9,11)	---						E: External Pilot	T: Internal Drain	51		
						10	2	N: No-Spring	2,4, 40 (3,7) *1									A *2 (Omit if not Required)	E: External Pilot
						B: Spring Offset	2,4, 40, (3,7) *1	A *2 B *2 (Omit if not Required)											

Note :

- Options are marked with *
- In spool type "3", "5", "6", "60" and "7", the combination applicable between pilot system & drain system is as described in the table below.

** Before ordering the Special Seals, consult CNIP INDIA LTD.

Pilot connection	Drain Connection	Care in Application
Internal Pilot	External Drain	Hold back pressure in the tank line so that the difference between pilot pressure and drain pressure is always more than minimum required pilot pressure
	Internal Drain (T)	Combination not available.
External Pilot (E)	External Drain	No Limitation in use.
	Internal Drain (T)	

*1 Shockless type (S-DSHG) are not available for spool type marked ().

*2 Other spool types for special 2-position valves are available in addition to spool type 2, 3, 4, 40 and 7.

[Refer to the column "valves with centre position and one offset position" (Special 2-position valve) on page 362.

*3 Coil type "R" is not available for plug-in connector with Indicator type "N1".

Solenoid Ratings

Solenoid ratings of pilot valve are identical with those of standard solenoid valve. Refer to relevant solenoid ratings described on the page below.

Model Numbers	Pilot Valve Model Numbers	Solenoid Rating described on The page below
(S-)DSHG-04	DSG-01-***-50	EIC-E-1001 Page No.331
(S-)DSHG-06		
(S-)DSHG-10		

Sub-plates

Valve Model Numbers	Sub-plate Model Numbers	Thread Size	Approx. Mass Kg
DSHG-04	DHGM-04-2080	1/2 BSP.F	4.4
	DHGM-04X-2080	3/4 BSP.F	4.1
DSHG-06	DHGM-06-5080	3/4 BSP.F	8.5
	DHGM-06X-5080	1 BSP.F	
DSHG-10	DHGM-10-4080	1-1/4 BSP.F	21.5
	DHGM-10X-4080	1-1/2 BSP.F	

- Sub-plates are available. Specify sub-plate model from the table above. When Sub-plates are not used, the mounting surface should have a good machined finish.

Mounting Bolts

Model Numbers	Name	Mounting Bolt	Qty.	Mounting Bolt Ordering Code
DSHG-04	Soc. Hd. Cap. Screw	M6 x 45 Lg.	2	BKDHG-04-50
		M10 x 50 Lg.	4	
DSHG-06	Soc. Hd. Cap. Screw	M12 x 60 Lg.	6	BKDHG-06-50
DSHG-10	Soc. Hd. Cap. Screw	M20 x 75 Lg.	6	BKDHG-10-40

Options

- Models with Pilot Choke Adjustment (C1/C2/C1C2)**

“C1” Models --- By turning the adjusting screw clockwise, main spool changeover speed by the pilot pressure can be lowered. But centering speed of spring centered modes can not be changed.

“C2” Models --- When the adjusting screw is turned clockwise, main spool changeover speed can be lowered and centering speed of spring centered models can be also lowered.

Graphic symbols (Ex. Spring Centered)

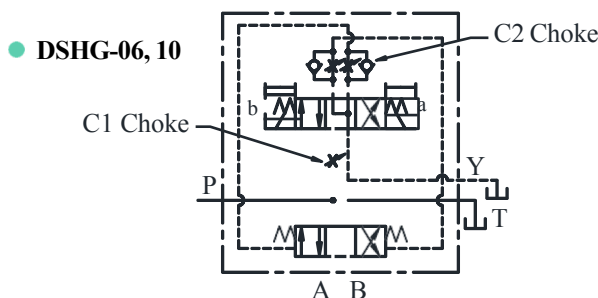
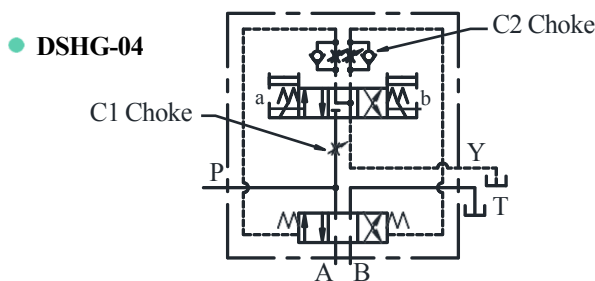

- Models with Pilot Stroke Adjustment (R2/RA/RB)**

When the adjusting screw is screwed in, the main spool stroke becomes short and flow rate reduces.

Graphic symbols (Ex. Spring Centered)

- “R2” Models

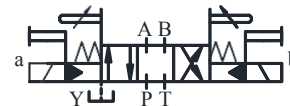

- “RA” Models

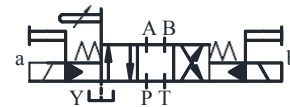

- “RB” Models

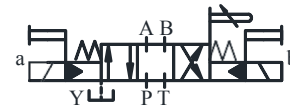

- Additional Mass of Options**

Add mass of options described below to mass of standard type if options are used.

Model Numbers	Models with Pilot Choke Adj.		Models With Stroke Adj.	
	C1,C2	C1C2	R2	RA RB
(S-)DSHG-04	0.65	1.3	1.0	0.5
(S-)DSHG-06	0.65	1.3	1.2	0.6
(S-)DSHG-10	0.65	1.3	3.7	1.85

List of Spool Functions (DSHG-04/S-DSHG-04)

Three Positions

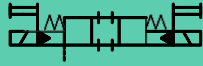

	DSHG-04-3C2	300	300	200	145
	S-DSHG-04-3C2	300	250	120	110
	DSHG-04-3C3	300	300	300	300
	DSHG-04-3C4	300	300	250	165
	S-DSHG-04-3C4	300	300	140	110
	DSHG-04-3C40	300	300	200	145
	S-DSHG-04-3C40	300	250	120	110
	DSHG-04-3C5	250	250	245	245
	DSHG-04-3C6	300	260	245	235
	DSHG-04-3C60	300	300	300	300
S-DSHG-04-3C60					
	DSHG-04-3C7	300	300	200	145
	DSHG-04-3C9	300	300	280	250
	DSHG-04-3C10	300	300	200	150
	S-DSHG-04-3C10	300	250	120	110
	DSHG-04-3C11	300	260	160	140
	DSHG-04-3C12	300	280	170	135
	S-DSHG-04-3C12	300	250	120	110

Two Positions



	(S-)DSHG-04-2N2	300	300	300	300	(S-)DSHG-04-2B2	300	300	300	300
	DSHG-04-2N3	300	300	300	300	DSHG-04-2B3	300	300	300	300
	(S-)DSHG-04-2N4	300	300	300	300	(S-)DSHG-04-2B4	300	300	300	300
	(S-)DSHG-04-2N40	300	300	300	300	(S-)DSHG-04-2B40	300	300	300	300
	DSHG-04-2N7	300	300	300	300	DSHG-04-2B7	300	300	300	300

Note:

- 1 Max. Flow described above shows value at pilot pressure more than 6 Kg_f/cm².
- 2 Max. Flow shows value at the condition of the flow as shown in right figure P→A→B→T (or P→B→A→T).
Max. Flow differs according to hydraulic circuit, if port "A" or "B" is blocked. Consult Yuken for such application.
- 3 For values in the double row, upper is maximum flow at pilot pressure 5Kg_f/cm². (In case pressure centered model, pilot pressure is 5 Kg_f/cm²), lower is pilot pressure of 7 Kg_f/cm².

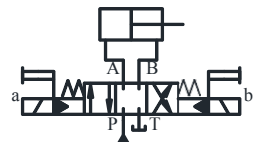





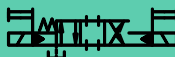
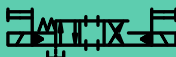

List of Spool Functions (DSHG-06/S-DSHG-06)

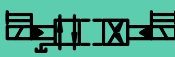
Three Positions

										
	(S-)DSHG-06-3C2	500	500	410 500	310 500	(S-)DSHG-06-3H2	500	500	500	420 500
	DSHG-06-3C3	500	500	460	370	DSHG-06-3H3	500	500	500	500
	(S-)DSHG-06-3C4	500	500	410 500	310 500	(S-)DSHG-06-3H4	500	500	500	420 500
	(S-)DSHG-06-3C40	500	500	410 500	310 500	(S-)DSHG-06-3H40	500	500	500	420 500
	DSHG-06-3C5	500	500	425	350	DSHG-06-3H5	500	500	500	470 500
	DSHG-06-3C6	475	390	300	230	DSHG-06-3H6	500	500	500	420 500
	(S-)DSHG-06-3C60	475	420	340	280	(S-)DSHG-06-3H60	500	500	500	420 500
	DSHG-06-3C7	500	500	450	360	DSHG-06-3H7	500	500	500	500
	DSHG-06-3C9	500	500	450 500	360 500	DSHG-06-3H9	500	500	500	500
	(S-)DSHG-06-3C10	500	500	410 500	310 500	(S-)DSHG-06-3H10	500	500	500	460 500
	DSHG-06-3C11	500	500	410 500	310 500	DSHG-06-3H11	500	500	500	460 500
	(S-)DSHG-06-3C12	500	500	410 500	310 500	(S-)DSHG-06-3H12	500	500	500	460 500

Two Positions

										
	(S-)DSHG-06-2N2	500	500	500	500	(S-)DSHG-06-2B2	500	500	500	500
	DSHG-06-2N3	500	500	500	500	DSHG-06-2B3	500	500	500	500
	(S-)DSHG-06-2N4	500	500	500	500	(S-)DSHG-06-2B4	500	500	500	500
	(S-)DSHG-06-2N40	500	500	500	500	(S-)DSHG-06-2B40	500	500	500	500
	DSHG-06-2N7	500	500	500	500	DSHG-06-2B7	500	500	500	500

Note: 1 Relation between max. flow and pilot pressure is:

- Value in the single column is constant regardless of pilot pressure subject to pilot pressure more than 8 Kgf/cm². In case pressure centered models, pilot pressure is more than 10 Kgf/cm².
- For values in the double row, upper is max. flow at pilot pressure 8 Kgf/cm². (In case pressure centered models, pilot pressure is 10 Kgf/cm² or more.) Lower is pilot pressure of 15 Kgf/cm².

2 Max. Flow shows value at the condition of the flow as shown in right figure

P→A→B→T (or P→B→A→T).



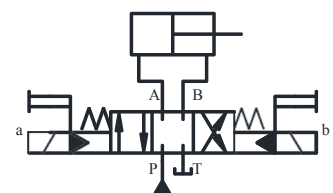







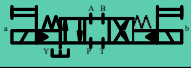
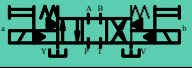

Max. Flow differs according to hydraulic circuit, if port "A" or "B" is blocked, consult Yuken for such application.



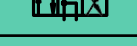





Solenoid Controlled Pilot Operated Directional Valves

List of Spool Functions (DSHG-10/S-DSHG-10)

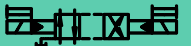
Three Positions

Spool Type	Spring Centered					Pressure Centered				
	Graphic Symbol 	Maximum Flow L/min				Graphic Symbol 	Maximum Flow L/min			
		100 Kgf/cm ²	160 Kgf/cm ²	250 Kgf/cm ²	315 Kgf/cm ²		100 Kgf/cm ²	160 Kgf/cm ²	250 Kgf/cm ²	315 Kgf/cm ²
"2" 	(S-)DSHG-10-3C2	1100	1100	950 1100	750 1100	(S-)DSHG-10-3H2	1100	1100	1100	970 1100
"3" 	DSHG-10-3C3	1100	1100	1060	895	DSHG-10-3H3	1100	1100	1100	1050 1100
"4" 	(S-)DSHG-10-3C4	1100	1100	950 1100	750 1100	(S-)DSHG-10-3H4	1100	1100	1100	970 1100
"40" 	(S-)DSHG-10-3C40	1100	1100	950 1100	750 1100	(S-)DSHG-10-3H40	1100	1100	1100	970 1100
"5" 	DSHG-10-3C5	1100	1100	980	850	DSHG-10-3H5	1100	1100	1100	1000 1100
"6" 	DSHG-06-3C6	1050	880	700	570	DSHG-10-3H6	1100	1100	1100	970 1100
"60" 	(S-)DSHG-10-3C60	1050	940	785	680	(S-)DSHG-10-3H60	1100	1100	1100	970 1100
"7" 	DSHG-10-3C7	1100	1100	1040 1100	870 1100	DSHG-10-3H7	1100	1100	1100	1100
"9" 	DSHG-10-3C9	1100	1100	1040	870	DSHG-10-3H9	1100	1100	1100	1100
"10" 	(S-)DSHG-10-3C10	1100	1100	950 1100	750 1100	(S-)DSHG-10-3H10	1100	1100	1100	1060 1100
"11" 	DSHG-10-3C11	1100	1100	950 1100	750 1100	DSHG-10-3H11	1100	1100	1100	1060 1100
"12" 	(S-)DSHG-10-3C12	1100	1100	950 1100	750 1100	(S-)DSHG-10-3H12	1100	1100	1100	1060 1100

Two Positions

										
	(S-)DSHG-10-2N2	1100	1100	1100	1100	(S-)DSHG-10-2B2	1100	1100	1100	1100
	DSHG-10-2N3	1100	1100	1100	1100	DSHG-10-2B3	1100	1100	1100	1100
	(S-)DSHG-10-2N4	1100	1100	1100	1100	(S-)DSHG-10-2B4	1100	1100	1100	1100
	(S-)DSHG-10-2N40	1100	1100	1100	1100	(S-)DSHG-10-2B40	1100	1100	1100	1100
	DSHG-10-2N7	1100	1100	1100	1100	DSHG-10-2B7	1100	1100	1100	1100

Note :

- Relation between max. flow and pilot pressure is
 - Value in the single column is constant regardless of pilot pressure subject to pilot pressure more than 10 Kgf/cm².
 - For values in the double row, upper is max. flow at pilot pressure 10 Kgf/cm². Lower is pilot pressure of 15 Kgf/cm².
- Max. Flow shows value at the condition of the flow as shown in right figure
 P→A→B→T (or P→B→A→T).
 Max. Flow differs according to hydraulic circuit, if port "A" or "B" is Blocked, consult Yuken for such application.

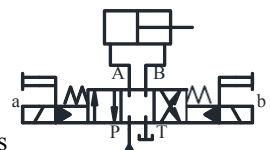

Spring Offset Valves with Alternate Solenoid

Though our standard spring offset models use solenoid "b", alternate models using solenoid "a" are also available. The graphic symbols are expressed as below.
For Models 2B※-A and 2B※B, refer to table as below.

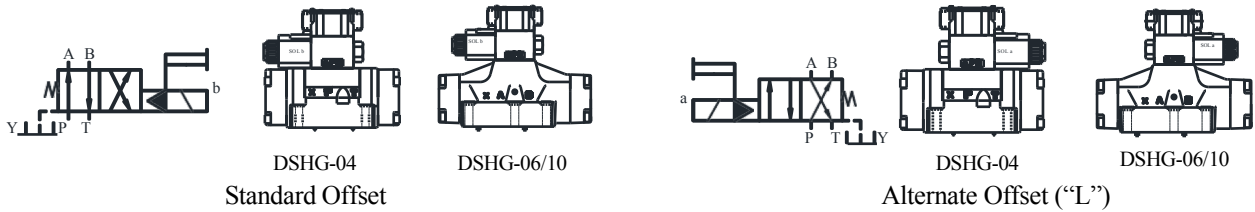

Valve with Centre Position and One Offset Position (Special Two Position Valve)

In addition to the standard two position valves as shown in the table on pages 360 to 362 two kinds of valves are available with center position and either one of two offset positions.
Standard and alternate offset types use solenoid "b" and solenoid "a" respectively.

(Example) In case of spool Type "2"

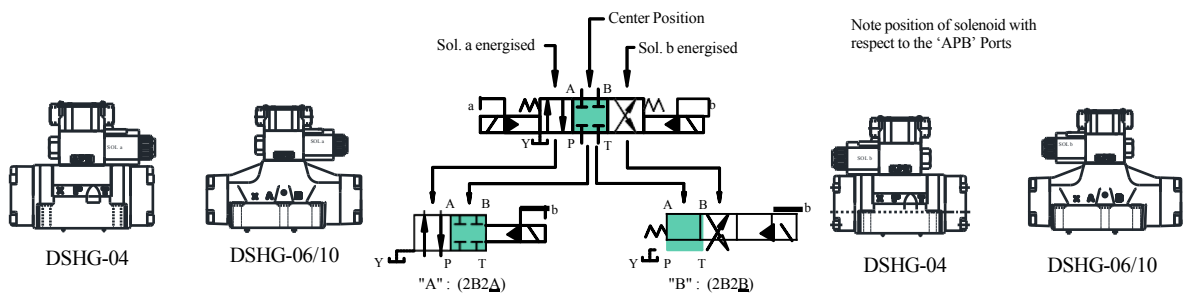

Model Numbers	Graphic Symbols		Model Numbers	Graphic Symbols		Model Numbers	Graphic Symbols
	Standard Offset Type	Alternate Offset Type		Standard Offset Type	Alternate Offset Type		Standard Offset Type
04 ※-DSHG-06-2B※ 10			04 ※-DSHG-06-2B※ 10			04 ※-DSHG-06-2N※ 10	
(S-)DSHG-※2B2A			(S-)DSHG-※2B2B			(S-)DSHG-※2N2A	
DSHG-※2B3A			DSHG-※2B3B			DSHG-※2N3A	
(S)DSHG-※2B4A			(S-)DSHG-※2B4B			(S-)DSHG-※2N4A	
(S-)DSHG-※2B40A			(S-)DSHG-※2B40B			(S-)DSHG-※2N40A	
DSHG-※2B5A			DSHG-※2B5B			DSHG-※2N5A	
DSHG-※2B6A			DSHG-※2B6B			DSHG-※2N6A	
(S-)DSHG-※2B60A			(S-)DSHG-※2B60B			(S-)DSHG-※2N60A	
DSHG-※2B7A			DSHG-※2B7B			DSHG-※2N7A	
DSHG-※2B9A			DSHG-※2B9B			DSHG-※2N9A	
(S-)DSHG-※2B10A			(S-)DSHG-※2B10B			(S-)DSHG-※2N10A	
DSHG-※2B11A			DSHG-※2B11B			DSHG-※2N11A	
(S-)DSHG-※2B12A			(S-)DSHG-※2B12B			(S-)DSHG-※2N12A	

Pressure Drop

Pressure drop curves based on viscosity of 35cSt and specify gravity of 0.850.

DSHG-04, S-DSHG-04

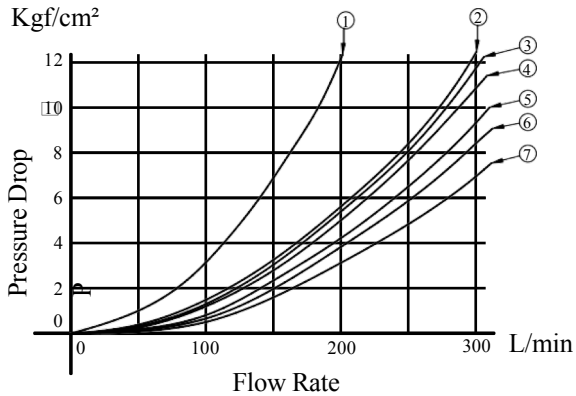

Spool Type	Pressure Drop Curve Numbers					Spool Type	Pressure Drop Curve Numbers				
	P□A	B□T	P□B	A□T	P□T		P□A	B□T	P□B	A□T	P□T
2	⑤(2)	④(2)	⑤(2)	⑥(4)	□	60	⑦	⑤	⑦	⑦	②
3	⑤	③	⑤	⑤	⑦	7	⑤	④	⑤	⑥	□
4	⑤(2)	③(3)	⑤(2)	⑤(5)	□	9	⑤	④	⑤	⑥	□
40	⑤(2)	④(4)	⑤(2)	⑥(6)	□	10	⑤(2)	②(2)	⑤(2)	⑥(4)	□
5	⑦	④	⑤	⑤	⑤	11	⑥	④	⑤	⑥	□
6	⑤(6)	③(4)	⑤(6)	⑥(7)	①(2)	12	⑤(2)	④(2)	⑤(2)	⑤(5)	□

Note : Figures enclosed () shows curve number for shockless type (S-DSHG-04).

DSHG-06, S-DSHG-06

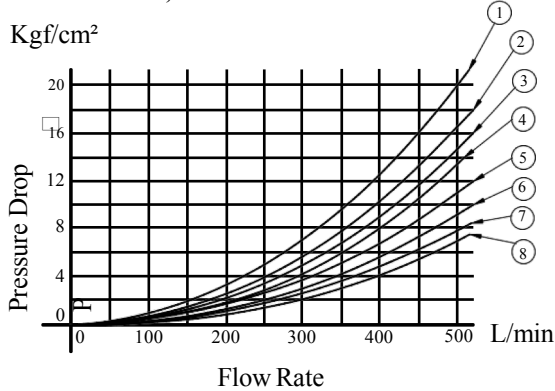

2	⑧(6)	⑤(1)	⑧(6)	⑦(2)	□	60	⑤(6)	⑤(2)	⑥(6)	⑦(3)	③(10)
3	⑥	④	⑥	⑦	⑥	7	⑥	④	⑥	⑦	□
4	⑧(6)	⑤(2)	⑧(6)	⑦(2)	□	9	⑥	⑤	⑥	⑦	□
40	⑧	⑤	⑧	⑦	□	10	⑧	⑤	⑧	⑦	□
5	⑧	④	⑤	⑦	②	11	⑧	④	⑤	⑦	□
6	⑤	①	⑤	④	③	12	⑧	⑤	⑧	⑦	□

DSHG-10, S-DSHG-10

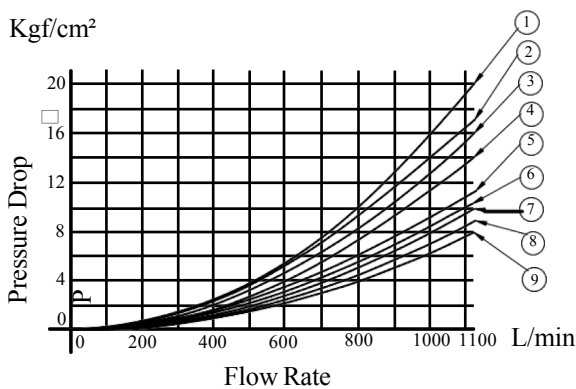

2	⑨(8)	⑥(3)	⑨(8)	⑧(4)	□	60	⑧(8)	⑤(4)	⑧(8)	⑤(4)	③(2)
3	⑦	⑥	⑦	⑦	⑤	7	⑦	⑥	⑦	⑦	□
4	⑨(8)	⑥(5)	⑨(8)	⑥(6)	□	9	⑦	⑥	⑦	⑦	□
40	⑨	⑥	⑨	⑧	□	10	⑨	⑤	⑨	⑧	□
5	⑨	⑥	⑧	⑥	①	11	⑨	⑥	⑧	⑦	□
6	⑤	③	⑤	④	②	12	⑨	⑦	⑨	⑥	□

For any other viscosity, multiply by the factors in the table right.

For any other specific gravity (G'), the pressure drop (P') may be obtained from the formula below.

$$\Delta P' = \Delta P (G'/0.850)$$

Viscosity cSt	15	20	30	40	50	60	70	80	90	100
Factor	0.81	0.87	0.96	1.03	1.09	1.14	1.19	1.23	1.27	1.30

Typical Changeover Time

Changeover time varies according to oil viscosity, spool type and hydraulic circuit.

[Test Conditions]

Coil Type : D (Models with DC Solenoids)

Voltage : Rated Voltage

Oil viscosity : 35cSt

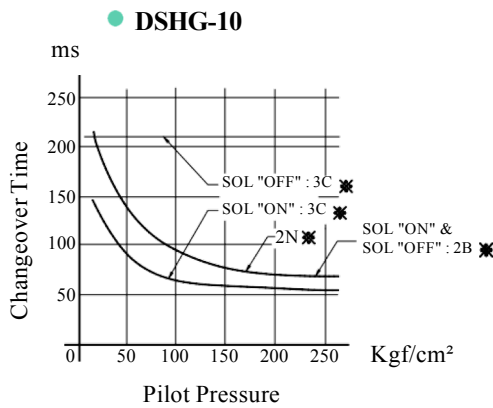
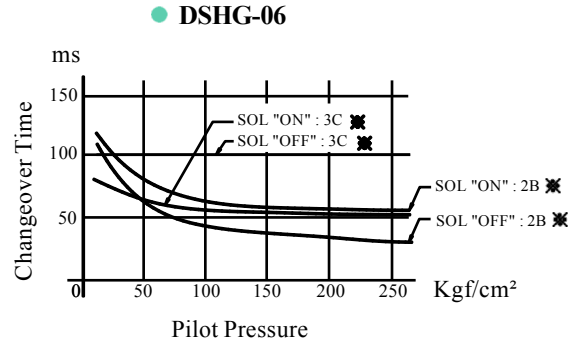
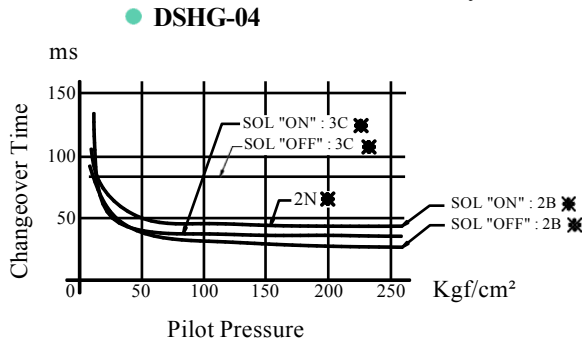

Plug-in Connector Type: (S-) DSHG-04 * * * * * N₁-50

Mounting Surface:
ISO 4401-AD-07-4-A

DIMENSIONS IN
MILLIMETRES

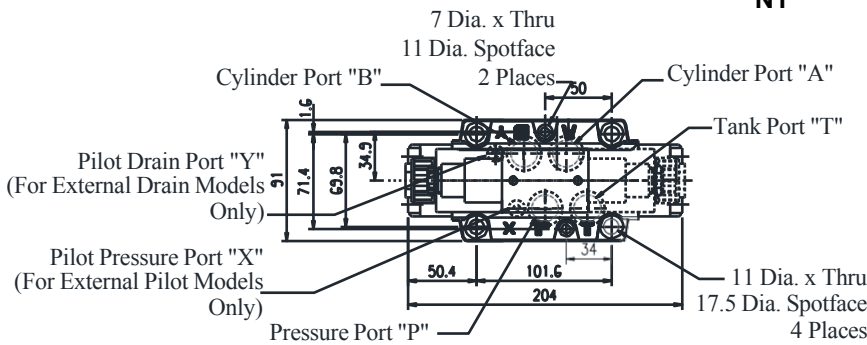

* Position of cable departure can be changed. For details, refer to DSG-01 valves on EIC-E-1001 Page 339.

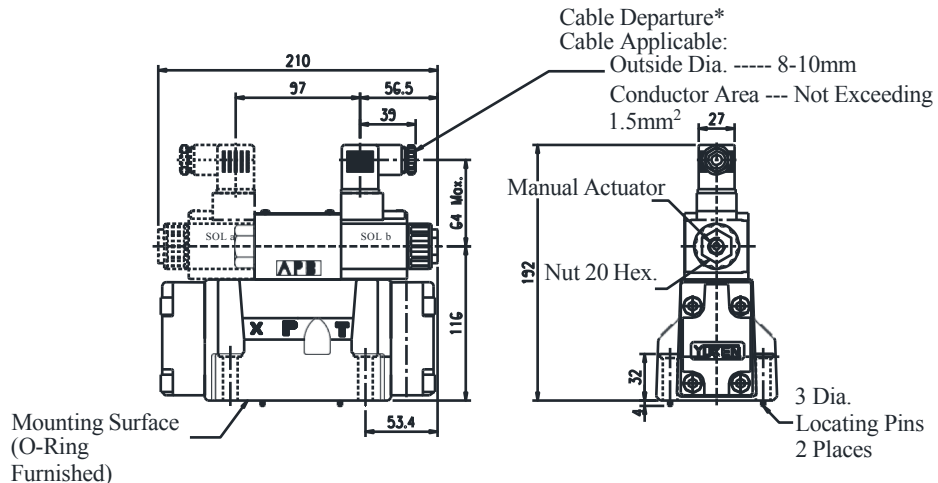

Solenoid Controlled Pilot Operated Directional Valves

Terminal Box Type : (S)-DSHG-04-※※※-※-50

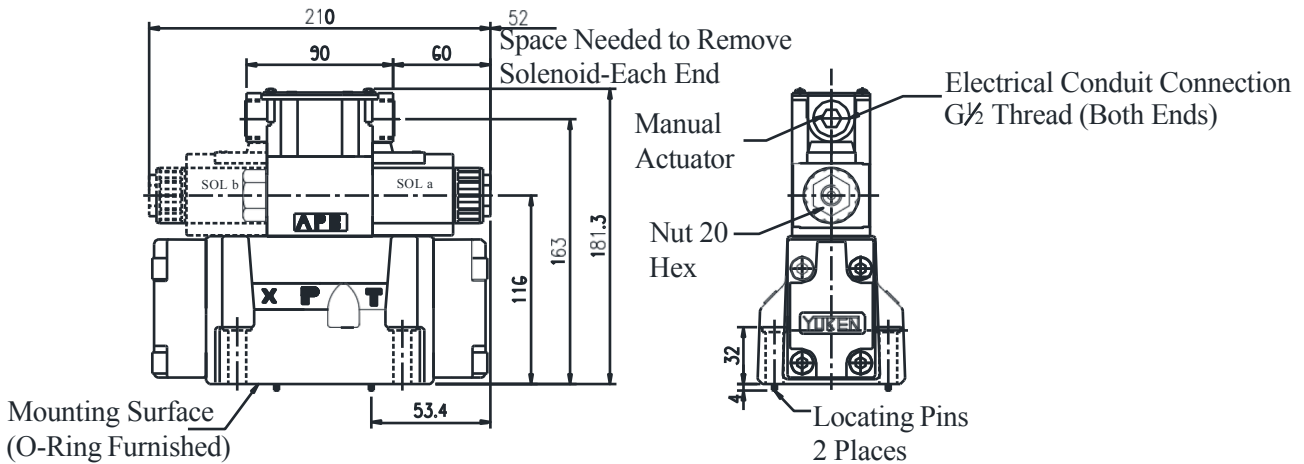

Plug-in Connector Type : (S)-DSHG-06-※※※-※- $\frac{N}{N1}$ -51

Mounting Surface:
ISO 4401-AE-08-4-A

DIMENSIONS IN
MILLIMETRES

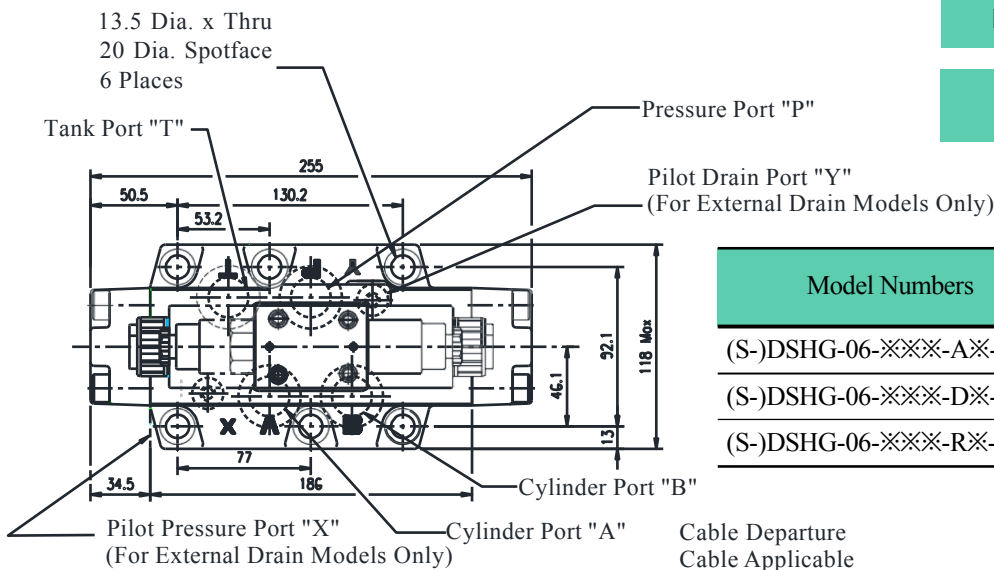

Model Numbers	Dimensions mm			
	C	D	E	F
(S)-DSHG-06-※※※-A※-N/N1	39	53	202	27.5
(S)-DSHG-06-※※※-D※-N/N1	39	64	213	27.5
(S)-DSHG-06-※※※-R※-N	53	57.2	216	34

Cable Departure
Cable Applicable

Outside Dia. ----- 8-10mm
Conductor Area --- Not Exceeding 1.5mm²

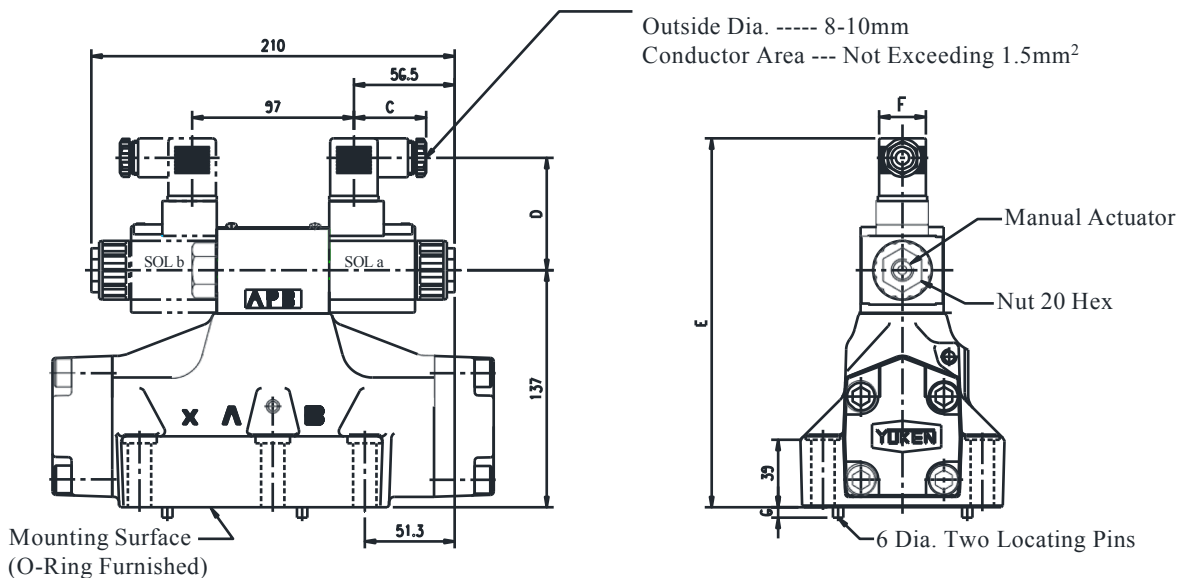

Position of cable departure can be changed. For details, refer to DSG-01 valve on EIC-E-1001 Page 339.

Solenoid Controlled Pilot Operated Directional Valves

Terminal Box Type : (S)-DSHG-06-***-51

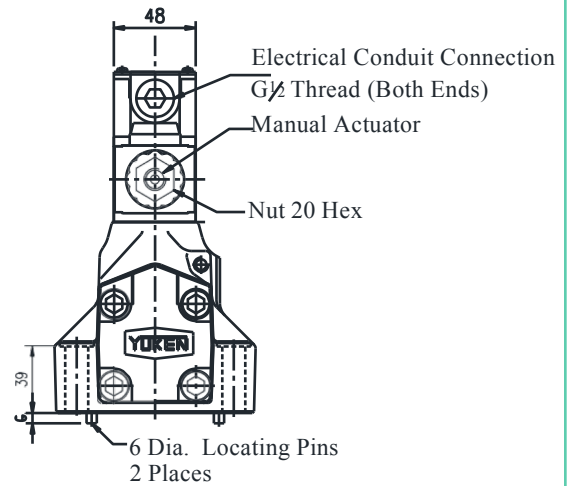
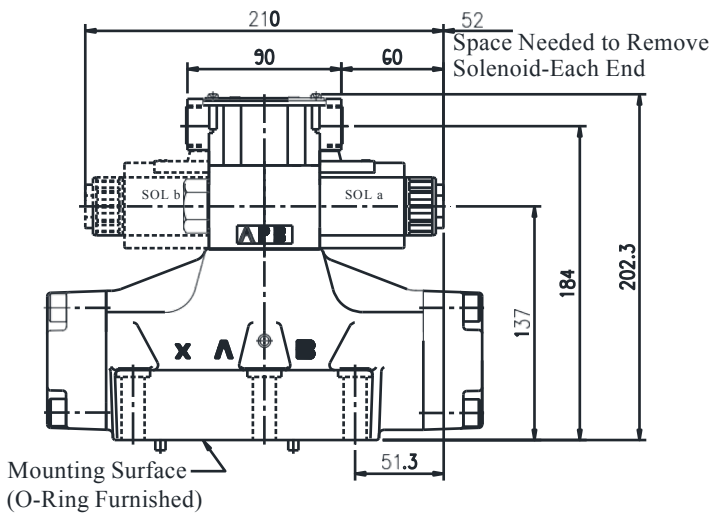

Plug-in Connector Type : (S)-DSHG-10-***-N-41

Mounting Surface:
ISO 4401-AE-10-4-A

**DIMENSIONS IN
MILLIMETRES**

E

DSG-03 Series Solenoid
Operated Directional Valves

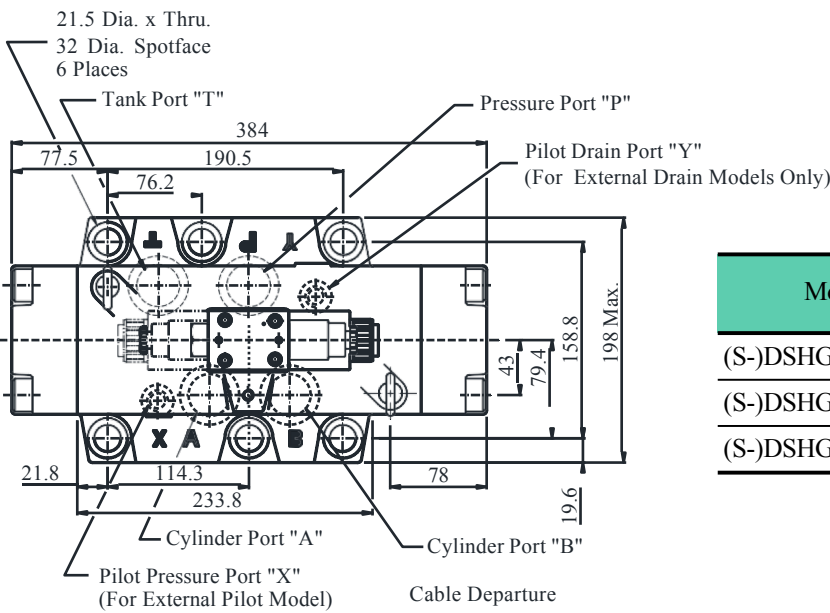

Model Numbers	Dimensions mm			
	C	D	E	F
(S)-DSHG-10-***-A*-N/N1	39	53	265	27.5
(S)-DSHG-10-***-D*-N/N1	39	64	276	27.5
(S)-DSHG-10-***-R*-N	53	57.2	279	34

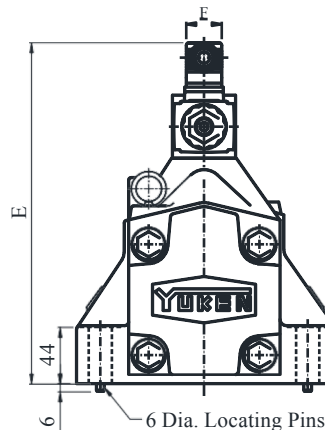
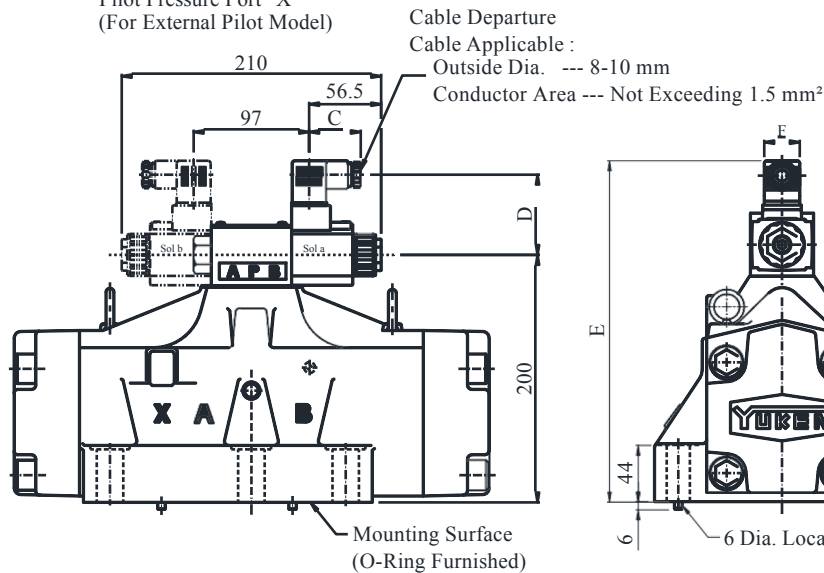

Position of cable departure can be changed. For details, refer to DSG-01 valve on EIC-E-1001 Page 339.

Solenoid Controlled Pilot Operated Directional Valves

Terminal Box Type : (S-)DSHG-10-***-41

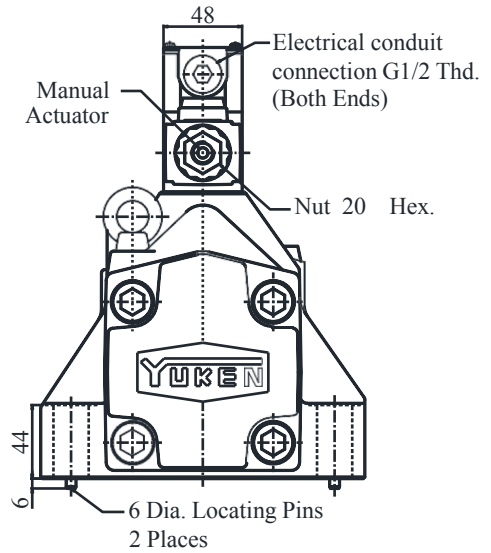
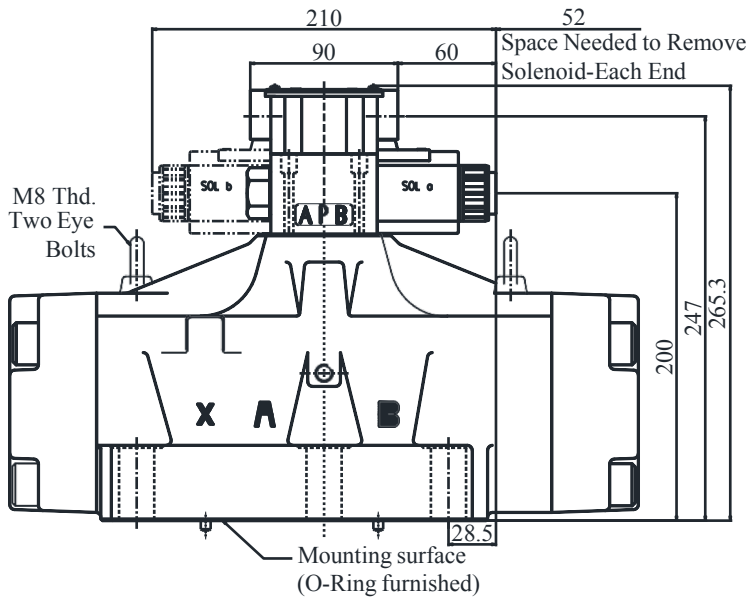

DIMENSIONS IN MILLIMETRES

OPTIONS

Models with Pilot Choke valve

- (S-)DSHG-06-***-C1/C2/C1C2-⁰⁴₁₀ N
N1

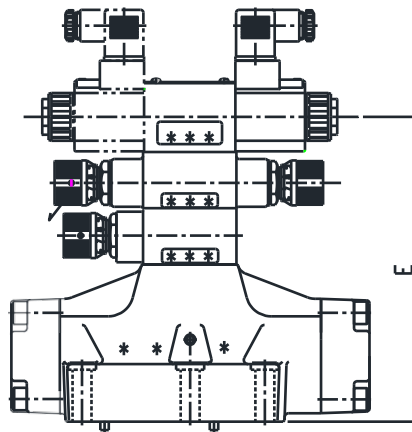
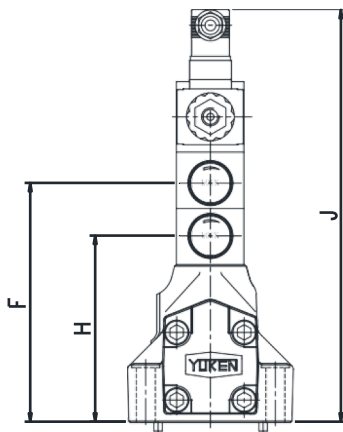

Model Numbers	Dimensions mm					
	E	F	H	J		
				AC SOL	DC SOL	R SOL
(S-)DSHG-04-***-C1	156	--	111	220	231	235
(S-)DSHG-04-***-C2	156	111	--	220	231	235
(S-)DSHG-04-***-C1C2	196	151	111	260	271	275
(S-)DSHG-06-***-C1	177	--	132	241	252	256
(S-)DSHG-06-***-C2	177	132	--	241	252	256
(S-)DSHG-06-***-C1C2	217	172	132	281	292	296
(S-)DSHG-10-***-C1	240	--	195	304	315	319
(S-)DSHG-10-***-C2	240	195	--	304	315	319
(S-)DSHG-10-***-C1C2	280	235	195	344	355	359

Solenoid Controlled Pilot Operated Directional Valves

OPTIONS

Models with Stroke Adjustment

04

- (S-)DSHG-06-***-R**

10

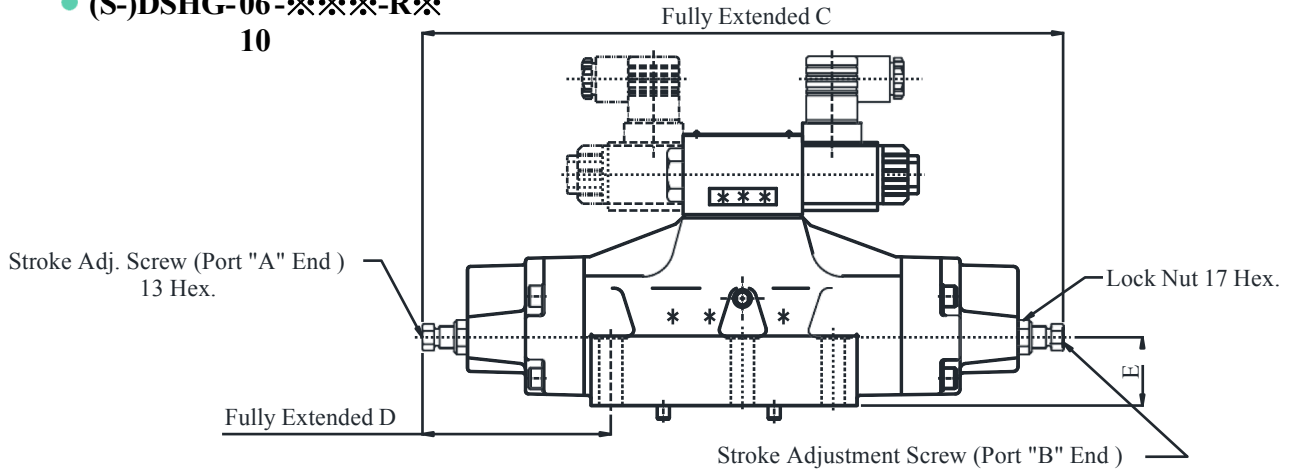

Model Numbers	C	D	E
(S-)DSHG-04-***-R2	288	94	33
(S-)DSHG-06-***-R2	376	111	40
(S-)DSHG-10-***-R2	558	164.5	65

DIMENSIONS IN MILLIMETRES

Sub-plate Model Numbers	"C" Thd.
DHGM-04-2080	1/2 BSP.F
DHGM-04X-2080	3/4 BSP.F

- Sub Plate DHGM-04-2080

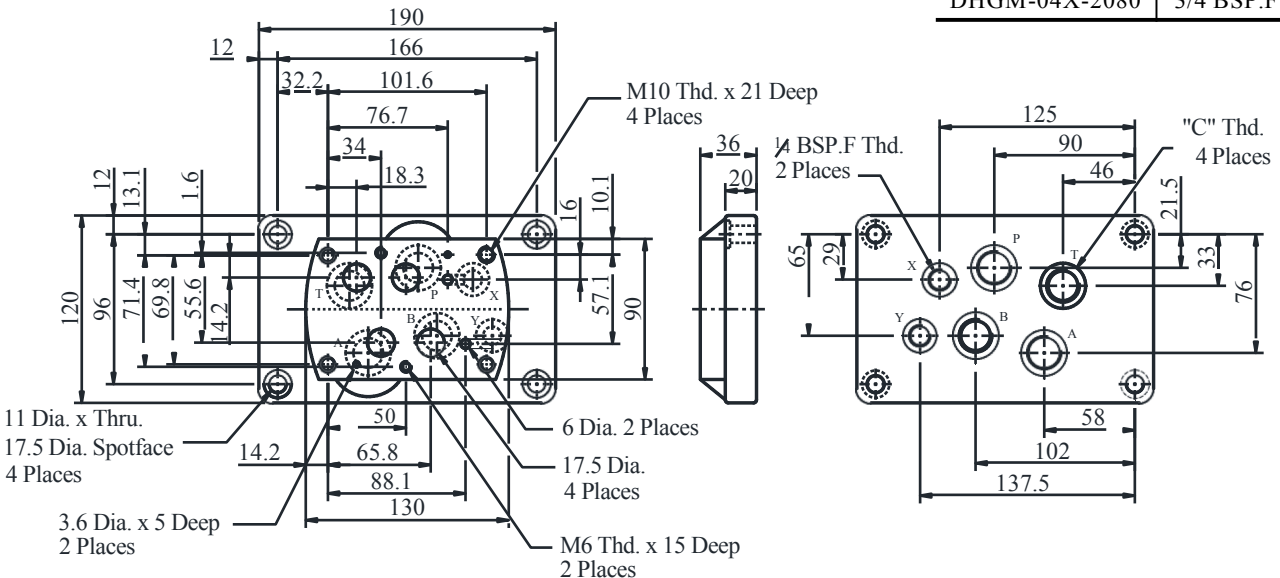

Valve Types		Pilot Pressure Port "X"	Port "Y"	Remarks
Solenoid Controlled Pilot Operated Directional Valves		Used only on external pilot type valves. To be plugged on internal pilot type Valves.	Used as drain port only on external drain type valves. To be plugged on internal pilot type Valves.	
Pilot Operated Directional Valves	Spring Centered No-Spring	Used	Used as pilot port	Normal size: Only 04
	Spring offset		Used as pilot drain port	
Manually Operated Direction Valves		Not used (plug is not required)	Used as drain port	

• DHGM-06-5080 06X

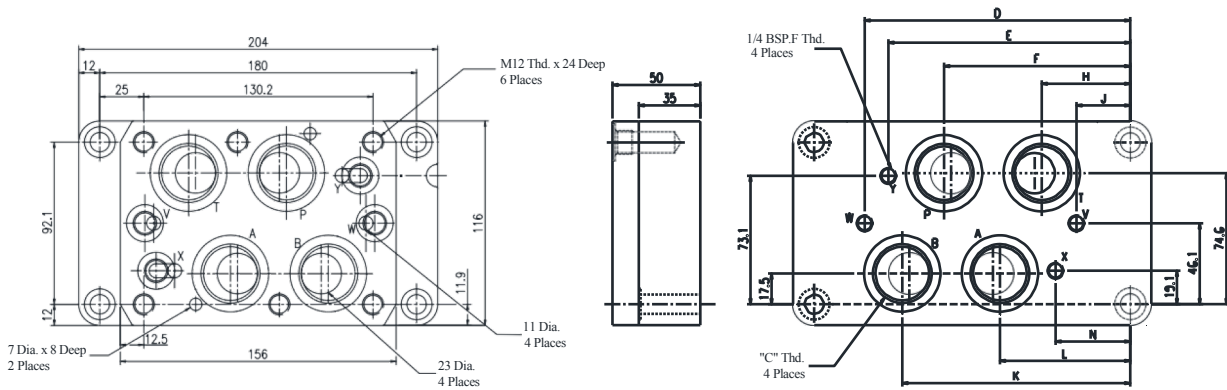

Sub-plate Model Numbers	"C" Thd.	Dimensions mm							
		D	E	F	H	J	K	L	N
DHGM-06-5080	¼ BSP.F	151.2	137.7	102	54.4	30.6	125.8	78.2	42.5
DHGM-06X-5080	1 BSP.F	155.2	148	106	50	25	130	74	32

For uses of Port "X", "Y", "V", "W", refer to DHGM-10-※

DIMENSIONS IN MILLIMETRES

• DHGM-10-4080 10X

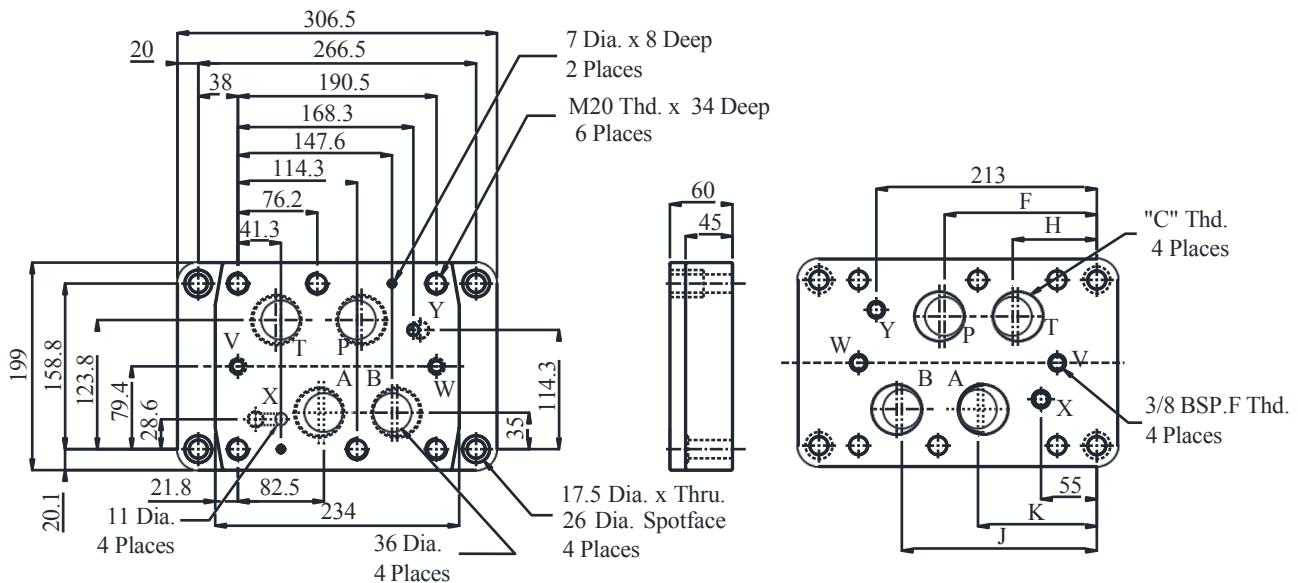

Sub-plate Model Numbers	"C" Thd.	Dimensions mm			
		F	H	J	K
DHGM-10-4080	1-1/4 BSP.F	152	79	185.5	120.5
DHGM-10X-4080	1-1/2 BSP.F	156	74	194.5	112.5

Note : Uses of port “X”, “Y”, “V” and “W”

Valve Types		Pilot Pres. Port “X”	Port “Y”	Port “V”	Port “W”
Solenoid Controlled Pilot Operated Directional Valves	Spring centered, No-spring, Spring offset	Used only on external pilot type valves. To be plugged on internal pilot type valves.	Used as drain port only on external drain type valves. To be plugged on * internal pilot type valves.	Not used (plug is not required)	
	Spring centered, No-spring, Spring offset	Used	Used as pilot pres. Port Used pilot port drain port	Not used (plug is not required)	
Manually Operated Directional Valves		Not used (plug is not required)	Not used (plug is not required)	Used	Not used (plug is not required)

* As the thread is provided on the body, plug either port on the sub-plate or port on the body.

Conversion of Internal Pilot/Drain :

Comparison of DSHG-04-46 and DSHG-04-50 for Internal Pilot Models.

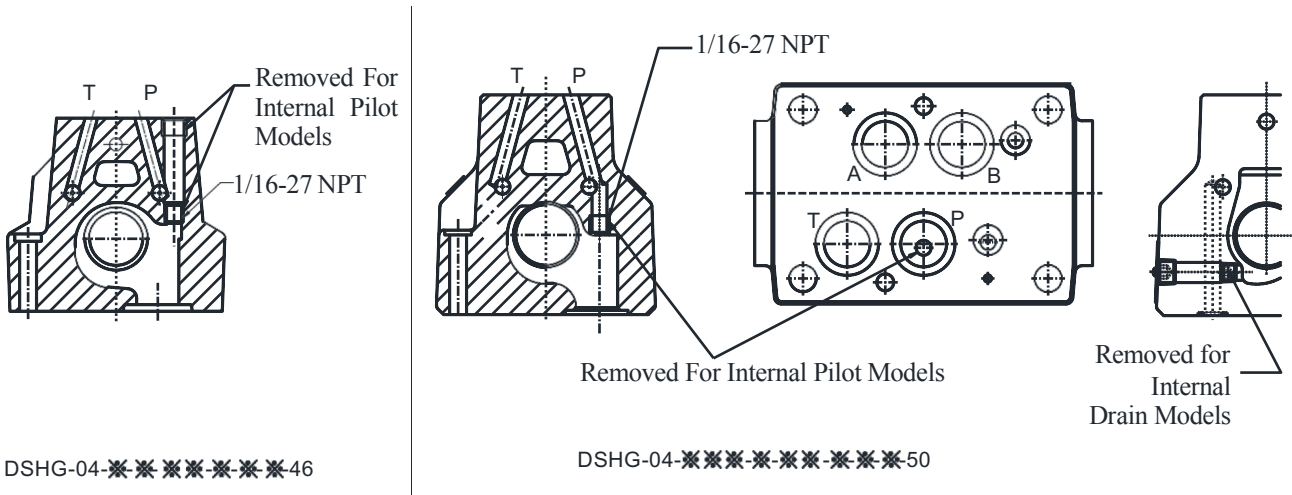

(S-)DSHG-06-*-***-51**

(S-)DSHG-10-*-***-41**

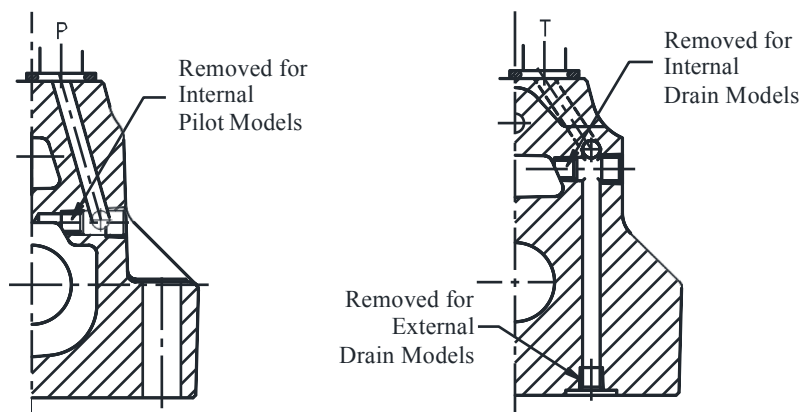

List of Pilot Valves

Valve Model Numbers	Pilot Valve Model Numbers
(S-)DSHG-04/06/10-3C※-★-▲	DSG-01-3C4-★-▲-50
(S-)DSHG-04-2B※-★-▲	DSG-01-2B2-★-▲-50
(S-)DSHG-06/10-2B※-★-▲	DSG-01-2B2-★-▲-50-L
(S-)DSHG-04/06/10-2N※-★-▲	DSG-01-2D2-★-▲-50

Notes:

- 1 Fill coil type (a symbol representing current/voltage) in section marked ★. Likewise, in selection marked ▲, fill a symbol representing the type of conduit connection (N: Plug-in connector type).
- 2 For the details of the pilot valves, see page EIC-E-1001 Page: 331.

Spare Parts List

List of Seals

Sl. No.	Name of Part	Part Numbers			Qty
		DSHG-04	DSHG-06	DSHG-10	
1	O-Ring	SO-NB-P9	--	--	4
2	O-Ring	--	SO-NB-P9	--	2
3	O-Ring	--	SO-NB-P14		2
4	O-Ring	--	--	SO-NB-P20	2
5	O-Ring	--	SO-NB-P30	--	4
6	O-Ring	SO-NB-P34	--	--	2
7	O-Ring	--	SO-NB-P40	--	2
8	O-Ring	--	--	SO-NB-P42	4
9	O-Ring	--	--	SO-NB-G65	2
10	O-Ring	SO-NB-P22	--	--	4

Note: When ordering the seals, please specify the Seal Kit number from the table below.

List of Seal kits

Valve Model Numbers	Seal Kit Numbers
DSHG-04	KS-DSHG-04-50
DSHG-06	KS-DSHG-06-51
DSHG-10	KS-DSHG-10-41

Note: When ordering the seals, please specify the Seal Kit number KS-DSHG-04-50/KS-DSHG-06-51/ KS-DSHG-10-41.