

Pilot Operated Directional Valves

These valves perform a change over of spool by hydraulic pilot and shift the direction of oil flow.

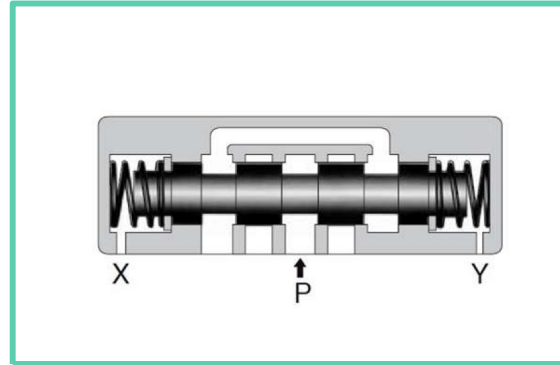
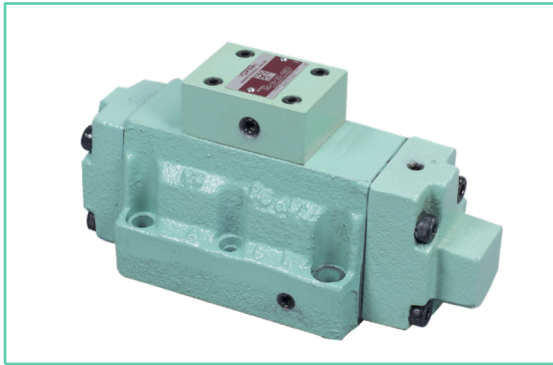

Specifications

Model Numbers	Maximum Flow L/min.				Max. Operating Pressure Kgf/cm ²	Max. Pilot Pressure Kgf/cm ²	Min. Required Pilot Pressure Kgf/cm ²	Max. T-Line Back Pres. Kgf/cm ²	Mass Kg
	100 Kgf/cm ²	160 Kgf/cm ²	250 Kgf/cm ²	315 Kgf/cm ²					
DHG-04-3C※-50	300 *1	300 *1	300 *1	300 *1	315	250	8	210	7.4
DHG-04-2N※-50	300	300	300	300					7.4
DHG-04-2B※-50	130	70	70	60					7.8
DHG-06-3C※-50	500 *2	500 *2	500 *2	500 *2	315	250	8	210	11.2
DHG-06-2N※-50	500	500	500	500					11.2
DHG-06-2B※-50	140	100	90	80					11.7
DHG-10-3C※-40	1100 *3	1100 *3	1100 *3	1100 *3	315	250	10	210	43.8
DHG-10-2N※-40	1100	1100	1100	1100					43.8
DHG-10-2B※-40	460	300	220	200					45.6

Note:

Max. flow refers to a ceiling flow which does not affect the normal function (changeover) of the valve. Also, max. flow in the above table indicates values when the flow condition is as shown in the right-hand figure.

P→A→B→T (or P→B→T→A→T).

Max. flow varies according to the circuit if port "A" or "B" is to be blocked. Consult yuken for such application.

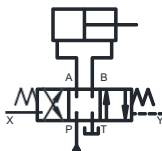

*1. Varies depending on the spool type.

*2. Varies depending on the spool type and pilot pressure. For more information, see page EIC-E-1003 Page No. 361 for the list of spool functions DSHG-06 the Solenoid Controlled Pilot Operated Directional Valves.

*3. Varies depending on the spool type and pilot pressure. For more information, see page EIC-E-1003 Page No. 362 for the list of spool functions DSHG-10 the Solenoid Controlled Pilot Operated Directional Valves.

*4. Minimum pilot pressure for the models with pilot piston is 18 Kgf/cm².

Pressure Drop

Same as those Solenoid Controlled Pilot operated Directional Valves. See page EIC-E-1003 Page 364 for the related information.

Instruction

Incase of spring offset models, directly connect the pilot pressure port "Y" to the reservoir as a drain port.

Model Number Designation

F-	DH	G	-04	-2	B	2	A	-C2	-RA	-50
Special Seals ^{**}	Series Number	Type of Connections	Valve Size	Number of Valves Positions	Spool Spring Arrangement	Spool Type	Special; Two Position Valve	Models with Pilot Choke Valve (Options)	Spool Control Modifications (Options) ^{*3}	Design Number
F: Special seals for Phosphate Ester Type Fluids (Omit if not required)	DH: Pilot Operated Directional Valve	G: Sub- Plate Mounting	04 06 10	3 2	C: Spring Centered N: No-Spring B: Spring Offset Refer to ^{*1}	2 . 3 4 . 40 5 . 6 60 . 7 9 . 10 11 . 12	A ^{*2} B ^{*2} (Omit if not required)	C2: With C2 Choke	R2: With stroke Adjustment, Both Ends RA: With stroke Adjustment, Port A End RB: With stroke Adjustment, Port B End	50 50 40











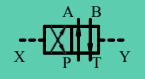



^{*1} For various combinations, see the List of valve types below.

^{*2} Refer to the column “valves with center position” (Special 2-position valve) on page 376.

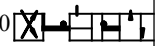
^{*3} For the option combinations of the Type (Valve Size) and Options, see the List of Options below.

^{**} Before ordering the Special seals, consult CNIP INDIA LTD.

List of Valve Type

Spool Type	Valve Types		
	Three Positions	Two Positions	
	Spring centred	No Spring	Spring Offset
	Graphic Symbol		
			
2		3C2	2N2 2B2
3		3C3	2N3 2B3
4		3C4	2N4 2B4
40		3C40	2N40 2B40
5		3C5	
6		3C6	
60		3C60	
7		3C7	2N7 2B7
9		3C9	
10		3C10	
11		3C11	
12		3C12	

List of Options

Model Numbers	Option Code			
	C2	R2	RA	RB
DHG-04-3C※	O	O	O	O
DHG-04-2N※	O	O	O	O
DHG-04-2B※	O	X	O	X
DHG-06-3C※	O	O	O	O
DHG-06-2N※	O	O	O	O
DHG-06-2B※	O	X	O	X
DHG-10-3C※	O	O	O	O
DHG-10-2N※	O	O	O	O
DHG-10-2B※	O	X	O	X

Note : O Mark : Available
X Mark : Not Available

● Sub-plate

Valve Model Numbers	Sub-Plate Model numbers	Thread Size	Approx. Mass Kg
DHG-04	DHGM-04-2080	1/2 BSP.F	4.4
	DHGM-04X-2080	3/4 BSP.F	4.1
DHG-06	DHGM-06-5080	3/4 BSP.F	8.5
	DHGM-06X-5080	1 BSP.F	
DHG-10	DHGM-10-4080	1-1/4 BSP.F	21.5
	DHGM-10X-4080	1-1/2 BSP.F	

- Sub-plates are available. Specify sub-plate model from the above. When sub-plates are not used, the mounting surface should have a good machined finish.
- Sub-plates are shared with those for Solenoid Controlled Pilot Operated Directional Valves. Refer EIC-E-1003 page 369 and 370 for dimensions.

■ Mounting Bolts

Model Number	Soc. Hd. Cap Screw	Qty.	Mounting Bolt Kit Number
DHG-04	M6 x 45 Lg.	2	BKDHG-04-50
	M10 x 50 Lg.	4	
DHG-06	M12 x 60 Lg.	6	BKDHG-06-50
DHG-10	M20 x 75 Lg.	6	BKDHG-10-40

■ Options

● Models with Pilot Choke Adjustment (C2)

To lower the changeover speed, turn the adjusting screw clockwise. In particular, the centering speed which is controlled by spring force can be lowered. This applies to spring centered models and Spring offset models. These models can be used in combination with Spring centered models, no-spring detented models, and models with stroke adjustment.

Graphic Symbol

Spring Centered Models

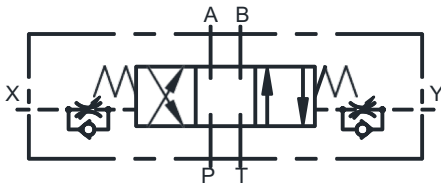

● Models with Stroke Adjustment (R※)

Graphic Symbol

Spring Centered Models with Stroke Adjustment on Both Ends (R2)

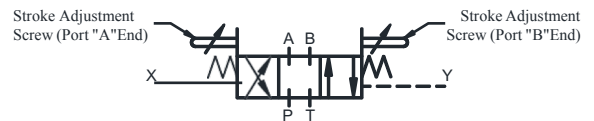

When the adjusting screw is screwed in, the spool stroke becomes shorter as flow rate reduces.

● Additional Mass of options

Add mass of options below to mass of standard type (see page -373) if options are used.

Model Numbers	With Pilot Choke Valve	With Stroke Adjustment	
		R2	RA RB
DHG-04	0.65	1.0	0.5
DHG-06	0.65	1.2	0.6
DHG-10	0.65	3.7	1.85

Valves with Centre Position and One Offset Position (Special Two Position Valves)

In addition to the standard Two Position Valves (2B※), the following two types of two position valves are available: Valves with neutral position and pilot Y pressure position (2B※A). Valves with neutral position and pilot X pressure position (2B※B).

Model Numbers	Graphic Symbols	Model Numbers	Graphic Symbols
04 DHG-06-2B※ <u>A</u> 10		04 DHG-06-2B※ <u>B</u> 10	
DHG-※2B2A		DHG-※2B2B	
DHG-※2B3A		DHG-※2B3B	
DHG-※2B4A		DHG-※2B4B	
DHG-※2B40A		DHG-※2B40B	
DHG-※2B5A		DHG-※2B5B	
DHG-※2B6A		DHG-※2B6B	
DHG-※2B60A		DHG-※2B60B	
DHG-※2B7A		DHG-※2B7B	
DHG-※2B9A		DHG-※2B9B	
DHG-※2B10A		DHG-※2B10B	
DHG-※2B11A		DHG-※2B11B	
DHG-※2B12A		DHG-※2B12B	

● DHG-04-※※※-50

DIMENSIONS IN MILLIMETRES

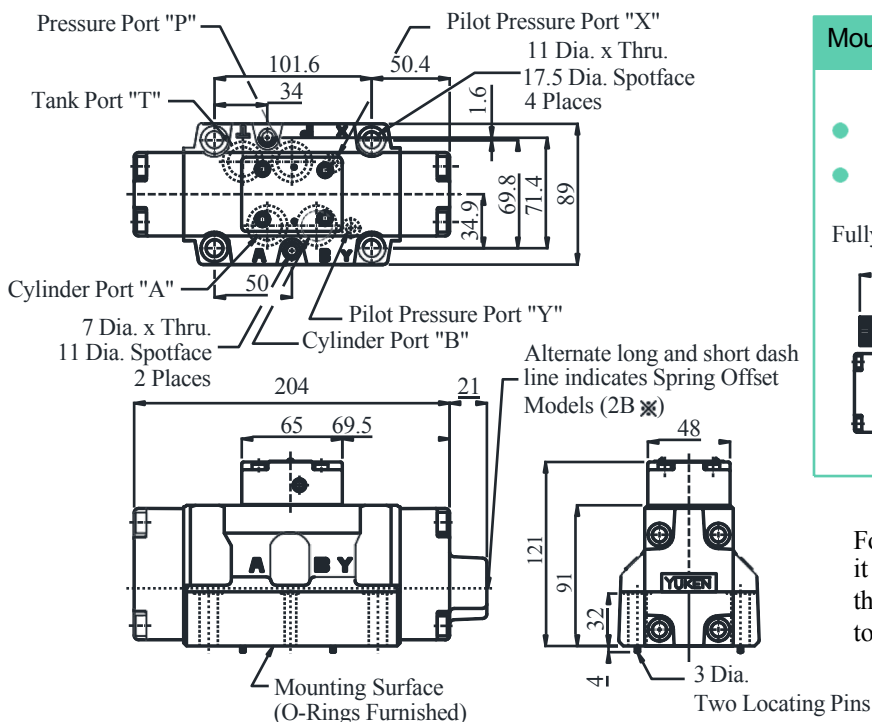

Mounting Surface: ISO 4401-AD-07-4-A

Options

- Models With Pilot Choke Valve
- DHG-04-※※※-50

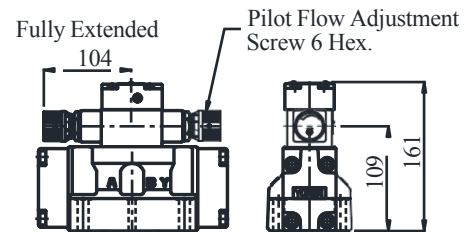

For Spring Offset Models (2B※, 2B※-A/B) it functions as a drain port. When that model is used directly connect it to the reservoir.

Note : For the valve mounting surface dimensions, see the dimensional drawing of the sharable sub-plate on EIC-E-1003 Page 369.

Pilot Operated Directional Valves

● **DHG-06-※※※-50**

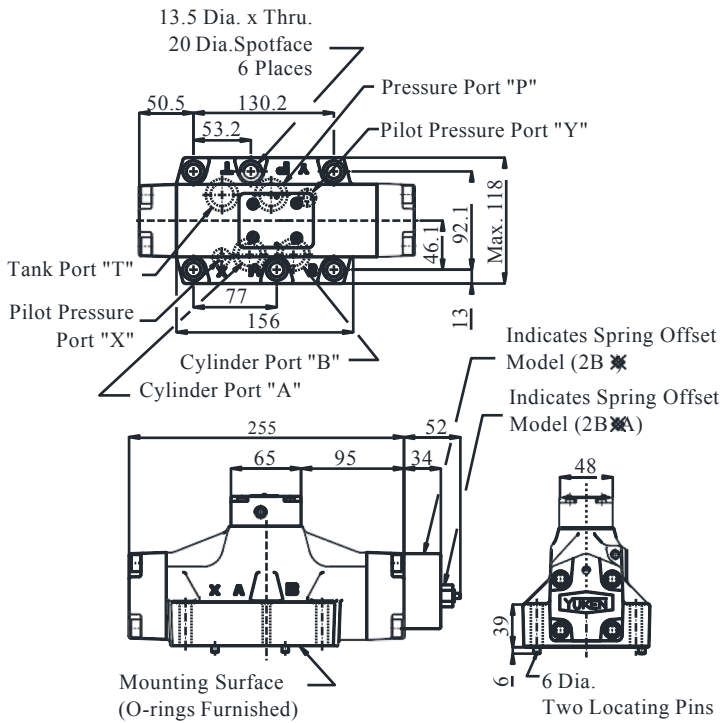

Note :

For the valve mounting surface dimensions, see the dimensional drawing of the sharable sub-plate in EIC-E-1003 Page 369

Mounting Surface: ISO 4401-AE-07-4-A

Options

● **Models With Pilot Choke Valve**
DHG-06-※※※-C2

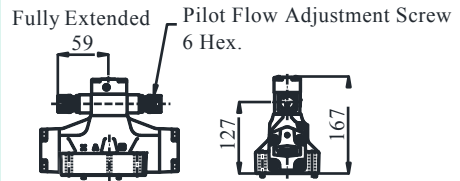

● **Models with Stroke Adj. (R※)**
Outside dimensions are the same as those of the main valve of Solenoid Controlled Pilot Operated Directional Valves (DSHG-06).
See EIC-E-1003 Page 366

In case of Spring Offset Models (2B※, 2B※^A_B) it functions as a drain port. When that model is used directly connect it to the reservoir.

E

DSG-03 Series Solenoid Operated Directional Valves

● **DHG-10-※※※-40**

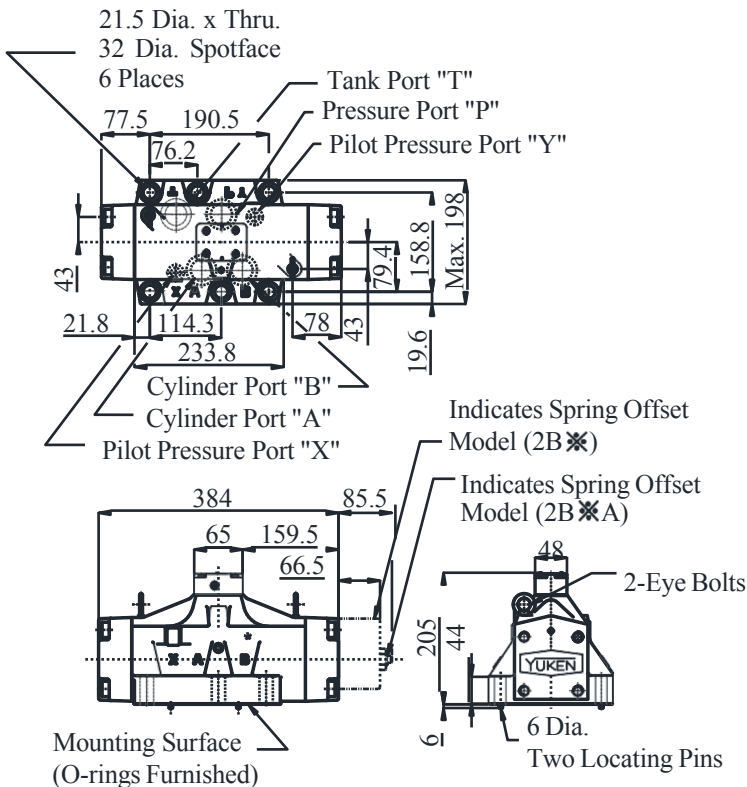

Note :

For the valve mounting surface dimensions, see the dimensional drawing of the sharable sub-plate in EIC-E-1003 Page 370

Mounting Surface: ISO 4401-AE-07-4-A

Options

● **Models With Pilot Choke Valve**
DHG-10-※※※-C2

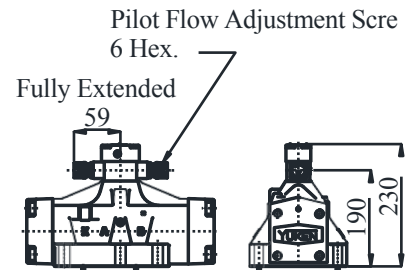

● **Models with Stroke Adj. (R※)**
Outside dimensions are the same as those of the main valve of Solenoid Controlled Pilot Operated Directional Valves (DSHG-10). See EIC-E-1003 Page 367

In case of Spring Offset Models (2B※, 2B※^A_B) it functions as a drain port. When that model is used directly connect it to the reservoir.

■ Spare Parts List

● List of Seals

Sl. No.	Name of Parts	DHG-04	DHG-06	DHG-10	Qty.
1	O-Ring	SO-NB-P9	--	--	8
2	O-Ring	--	SO-NB-P9	SO-NB-P9	4
3	O-Ring	SO-NB-P22	--	--	4
4	O-Ring	--	SO-NB-P10	SO-NB-P14	2
5	O-Ring	SO-NB-P34	--	--	2
6	O-Ring	--	SO-NB-P14	SO-NB-P20	2
7	O-Ring	--	SO-NB-P30	SO-NB-P42	4
8	O-Ring	--	SO-NB-P40	SO-NB-G65	2

Note: When ordering the seals, please specify the Seal Kit number from the table below.

● List of Seal kits

Valve Model Numbers	Seal Kit Numbers
DHG-04-※※※-50	KS-DHG-04-50
DHG-06-※※※-50	KS-DHG-06-50
DHG-10-※※※-40	KS-DHG-10-40