

Pilot Controlled Check Valves

These check valves allow flow in one direction and prevent flow in the reverse direction, until operated by pilot pressure to allow free reverse flow. The specified cracking pressure is required to open the valve to allow free flow direction.

Graphic Symbol



Internal Drain Type



External Drain Type

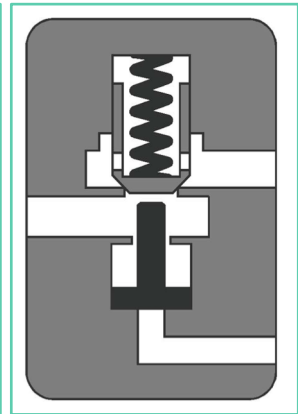

Specifications

Model Numbers		Rated Flow* L/Min.	Max. Operating Pres. Kgf/cm ²	Mass Kg
Sub-plate Mounting	CP※G-06-※-※-20	125	250	7

*Rated flow is the approximate flow rate, when there is a free flow pressure drop of maximum 3 Kgf/cm² the fluid has a specific gravity of 0.85, kinematic viscosity of 20cSt, and the cracking pressure is 0.4 Kgf/cm².

Model Number Designation

F-	CP	G	06	-E	-30	-20
Special Seals**	Series Number	Type of Connection	Valve Size	Drain Connection	Cracking Pres. Kgf/cm ²	Design Number
F: Special seals for phosphate ester type fluid (Omit if not required)	CP: Pilot Controlled Check Valve CPD: Decompression Type Pilot Controlled Check Valve	G: Sub-plate Mounting	06	None: Internal Drain E: External Drain	5 : 0.35 30 : 2.0 50 : 3.5 75 : 5.0	20

** Before ordering the Special Seals, consult YUKEN INDIA LTD.

Mounting Bolts

Valve Model Numbers	Socket head Cap screw	Qty.	Bolt Kit Model Number
CP※G-06	M10 x 80 Lg.	4	BKHCG-06-20

Sub-plates

Valve Model Numbers	Sub-plate Model Numbers	Thread Size	Approx. Mass Kg.
CP※G-06	HGM-06-2080	3/4 BSP.F	2.4
	HGM-06X-2080	1 BSP.F	3.0

- Sub-plates are available, specify sub-plate model from the table above. When sub-plates are used, the mounting surface should have a good machined finish.

Instructions

- Operation of internal drain and external drain types**
When the outlet side P1 is directly connected to the tank in reversed free flow (Fig. a), internal drain type is normally used. When the back pressure is applied to the outlet side P1 (Fig. b), be sure to use external drain type.
- Minimum pilot pressure characteristics**
That depends on the pressure of inlet side in the reversed free flow. This value can be determined from the characteristics chart.

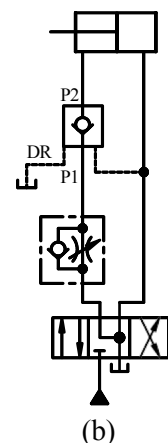
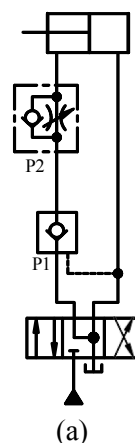

● **CPG -06-※-※-20**
CPDG

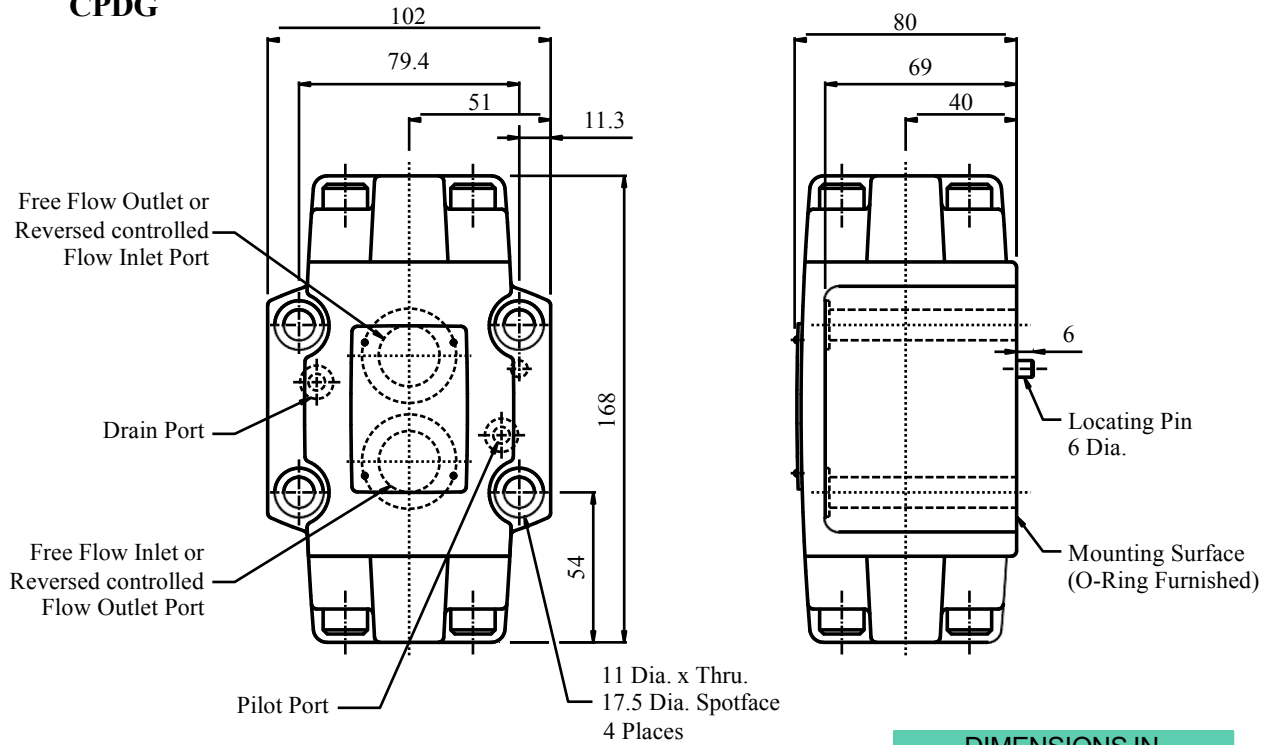

DIMENSIONS IN
MILLIMETRES

● **Sub-plate: HGM-06 -2080**
06X

Plug the drain port for the valve of internal drain type.

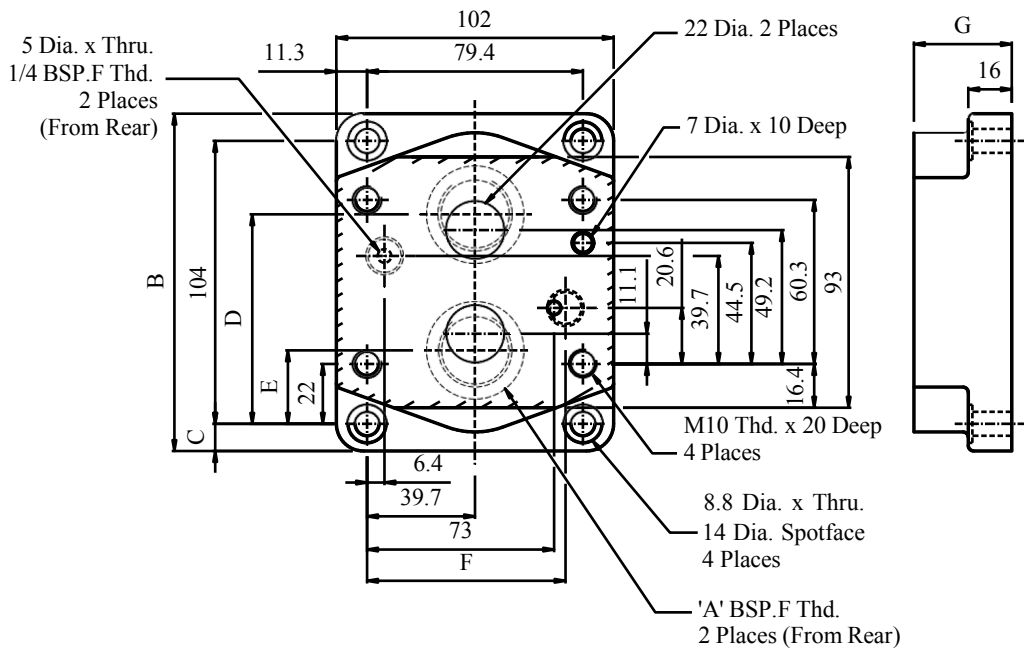

Sub-plate Model Numbers	A	B	C	D	E	F	G	Mass (Approx.) Kg.
HGM-06-2080	3/4	124	10	77	27	73	36	2.4
HGM-06X-2080	1	136	16	80	24	75	45	3

Mounting sub-plate are available on requests. Specify sub-plate model number from above table. When sub-plates are not used, mounting surface as shown by shaded area must be finished flat and smooth.

Pressure Drop for Free Flow

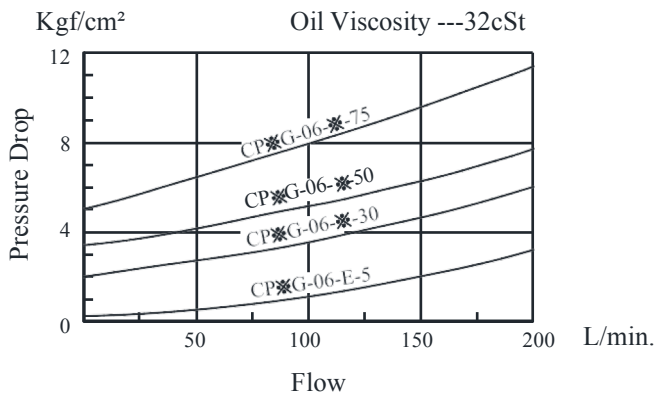

Pressure Drop for Reversed Controlled Flow.

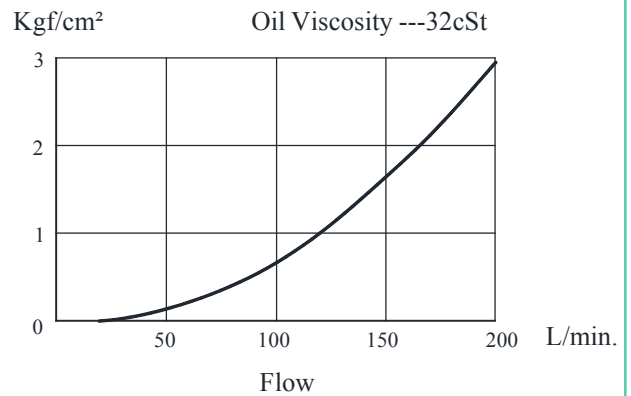

Pilot Pressure Chart

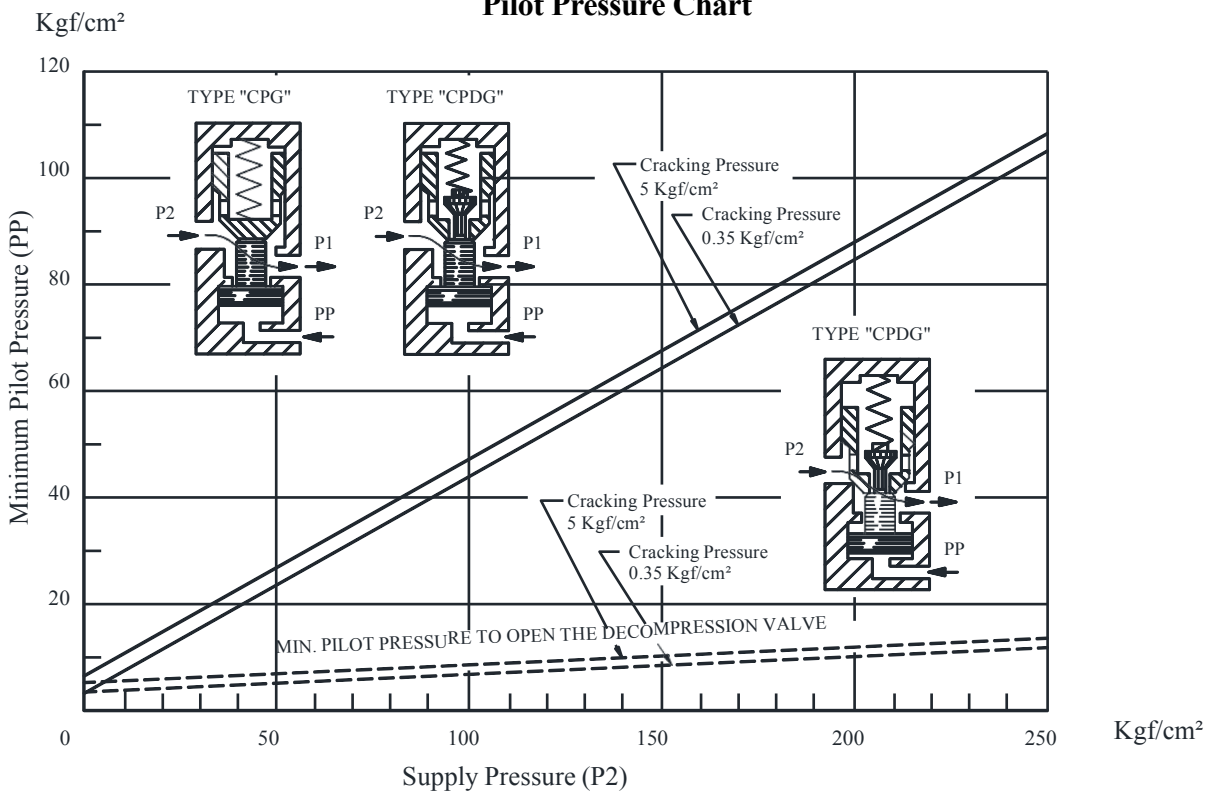

Pressure Drop For Reversed Controlled Flow Only When Decompression Valve is Opened

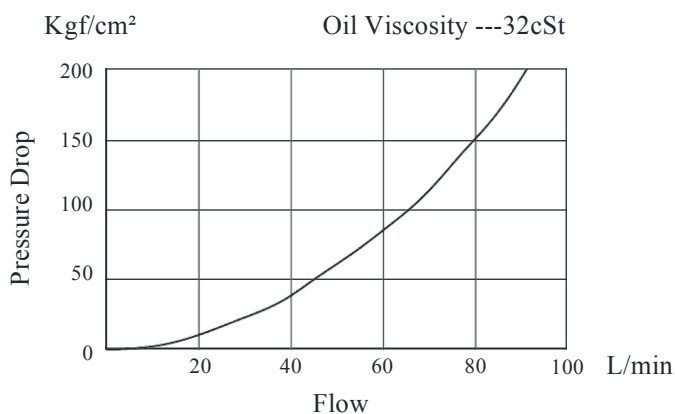

Spare Parts List

List of Seals

Sl. No.	Name of part	Part No.	Qty
1	O - Ring	SO-NB-P8	1
2	O - Ring	SO-NB-P9	2
3	O - Ring	SO-NB-P28	2
4	O - Ring	SO-NB-G35	2
5	O - Ring	SO-NA-P22A	1
6	Backup Ring	SO-BB-P22A	2

Note : When ordering the seals, please specify the seal kit number KS-CP*G-06-20