

3/8 Solenoid Operated Directional Valves, DSG-03 Series

- **WIDE RANGE OF MODELS - Choose the optimum valve to meet your needs from a large selection available.**

The DSG-03 50 series solenoid operated Directional valves are classified into two basic models:

- **Standard type** ----- Useable at high pressure, high flow [315 Kgf/cm² 120 L/min]
- **Shockless type** ----- which greatly reduces noise which is a result of spool changeover and vibration in pipes.

The optimum valve for any system can be utilized since many spool types and various solenoids are all available, along with other optional functions.



Graphical Symbols

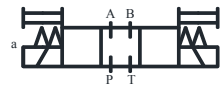

• 4 Way, 3 Position



• 4 Way, 2 Position

Specification

Valve Type	Model Numbers	Max. * Flow L/min.	Max. Operating Pressure Kgf/cm ²	Max. T-Line Back Pressure Kgf/cm ²	Max. Changeover Frequency Cycles/Min.	Mass Kg.	
						Type of solenoid	
						AC	DC,R,RQ
Standard Type	DSGM-03-3C※-※-50	120	315 {Spool Type 60 Only 250}	160	240 {R Type Sol. Only 120}	3.6	5
	DSGM-03-2D2※-※-50						
	DSGM-03-2B※-※-50					2.9	3.6
Shockless Type	S-DSGM-03-3C※-※-50	120	250	160	120	---	5
	S-DSGM-03-2B2※-※-50						3.6

* Maximum flow indicates a ceiling flow. As the ceiling flow depends on the type of spool and operating condition, refer to the list of spool functions on pages 347 and 348 for details.

Sub-Plates

Sub-Plate Model numbers	Thread Size	Approx. Mass Kg.
DSGM-03-2180	3/8 BSP.F	3.0
DSGM-03X-2180	1/2 BSP.F	3.0
DSGM-03Y-2180	3/4 BSP.F	4.7

* Sub-Plates are available. Specify sub-plate model from the table above. When sub-Plates are not used, the mounting surface should have a good machined finish.

Mounting Bolts

Four socket head cap screws as in the table below are included.

Soc. Hd. Cap Screw	Qty.	Bolt kit Model No.
M6 x 35 Lg.	4	BKDSG-03-20

Solenoid Ratings

Valve Type	Electric source	Coil Type	Frequency (Hz)	Voltage (V)		Current & Power at Rated Voltage					
				Source Rating	Serviceable Range	Inrush (A) *2	Holding (A)	Power (W)			
Standard Type	AC *1	A100	50	100	80 - 110	5.37	0.90	-			
			60	100	90 - 120	4.57	0.63				
				110		5.03	0.77				
			A120	50	120	96 - 132	4.48		0.75		
				60		108 - 144	3.81		0.52		
			A200	50	200	160 - 220	2.69		0.45		
		60		180 - 240		2.29	0.31				
						2.52	0.38				
		A240	50	240	192 - 264	2.24	0.37				
			60		216 - 288	1.91	0.26				
		Shockless Type	DC	D12	-	12	10.8 - 13.2		-	3.32	38
				D24		24	21.6 - 26.4			1.65	
D48	48			43.2 - 52.8		0.83					
D100	100			90 - 110		0.40					
D110	110			99 - 121		0.37					
D200	200			180 - 220		0.20					
D220	220			198 - 242		0.18					
AC & DC Rectified	50/60			R100		100	90 - 110	-		0.45	
		R110	110	99 - 121	0.41						
		R200	200	180 - 220	0.22						
		R220	220	198 - 242	0.20						

*1 AC solenoid is not available in shockless type.

R type models with built-in current rectifier is recommended for shockless operation with AC power.

*2 Inrush current in the above table show rms values at maximum stroke.

Model Number Designation

F-	S-	DSG	-03	-2	B	2	A	- A 100	- N	50	- L
Special ** Seals	Shock-Less Type	Series Number	Valve Size	Number of Valve Positions	Spool - Spring Arrangement	Spool Type	Special two Position Valve [Omit if not required]	Coil Type	Electrical Conduit Connection	Design *3 Number	Models with Alternate offset Solenoid [Omit if not required]
F: Special Seals for Phosphate Ester Type Fluids (Omit if not required)	None: Standard Type	DSG : Solenoid Operated Directional Valve	03	3 : Three Positions	C : Spring Centered	2, 3 4,40 5,60 7, 8 9,10 11,12	--	AC : A 100 A 120 A 200 A 240	None: *2 Terminal Box Type	50	--
				2 : Two Positions	D : No-Spring Detented	2, 3 7,8	*1 A	DC : D 12, D 24, D 48, D 100, D 110, D 200, D 220	N0 : Plug-in type, but Without Connector		
	B : Spring Offset				2, 3 8	*1 A *1 B	R : (AC & DC) R 100, R110 R 200, R220	N : With Plug-in Connector	L		
	S: Shock- Less Type			3 : Three Positions	C : Spring Centered	2,4, 40,60, 10,12	--	DC : D 12, D 24, D 48, D 100, D110, D 200, D 220	N1 : With Plug-in Connector with Indicator Light		--
2 : Two Positions		D : No-Spring Detented	2			R : (AC & DC) R 100, R110 R 200, R220		L			
		B : Spring Offset	2	*1 A *1 B							

*1 For 2-position valves, spool types in addition to 2,3,7 and 8 are available. Refer page no. 351.

*2 Consult CNIP for availability.

*3 Design numbers subject to change. But installation dimensions remain as shown for design number 50 through 59.

** Before ordering the Special seals, consult CNIP INDIA LTD.

DSG-03 Series Solenoid Operated Directional Valves

List of Standard Models and Maximum Flow

- Models with AC Solenoids: **DSG-03-***-A-***

No. of Valve Positions Spool-Spring Arrangements	Model Numbers	Graphic Symbols	Max. Flow L/min												
			100 Kg/f/cm ²	160 Kg/f/cm ²	250 Kg/f/cm ²	315 Kg/f/cm ²	100 Kg/f/cm ²	160 Kg/f/cm ²	250 Kg/f/cm ²	315 Kg/f/cm ²	100 Kg/f/cm ²	160 Kg/f/cm ²	250 Kg/f/cm ²	315 Kg/f/cm ²	
Three Positions Spring Centered	DSG-03-3C2		120	120	120	120	120	120	80	55	120	120	80	55	
	DSG-03-3C3*		120	120	120	120	120	120	54	43	120	120	54	43	
	DSG-03-3C4		120	120	120	120	120	120	84	64	120	120	84	64	
	DSG-03-3C40		120	120	120	120	120	120	65	53	120	120	65	53	
	DSG-03-3C5*		50	50	50	50	35	24	21	20	45	45	45	45	
	DSG-03-3C60*		120	120	120	--	120	120	--	--	120	120	120	--	
	DSG-03-3C7		120	120	120	45	120	120	67	35	120	120	67	35	
	DSG-03-3C8		--	--	--	--	120	120	45	31	120	120	45	31	
	DSG-03-3C9		120	120	120	120	100	100	79	57	100	100	79	57	
	DSG-03-3C10		120	120	120	65	120	120	57	51	120	120	57	51	
	DSG-03-3C11		120	120	120	50	100	100	46	40	100	100	46	40	
	DSG-03-3C12		120	120	120	65	120	120	51	40	100	100	51	40	
Two Positions No Spring Detented	DSG-03-2D2		120	120	120	120	45	37	30	28	60	60	40	35	
	DSG-03-2D3		120	120	120	120	45	37	30	28	60	60	40	35	
	DSG-03-2D7		120	120	120	120	45	37	30	28	60	60	40	35	
	DSG-03-2D8		--	--	--	--	60	60	40	35	60	60	45	35	
	Spring Offset	DSG-03-2B2		110	110	110	110	68	47	38	38	120	114	75	63
		DSG-03-2B3		120	120	120	120	77	77	77	77	120	120	120	120
		DSG-03-2B8		--	--	--	--	53	33	24	23	120	120	62	47
												62	40	37	37

Note: 1. Maximum flow rates and applied current.

- The single column describes maximum flow rates regardless AC solenoid 50 Hz or 60 Hz within serviceable voltage range.
- Maximum flow rates at 50 Hz solenoid with serviceable voltage range refer to the figures in the upper column and 60 Hz solenoid within serviceable voltage range refer to the figures in the later column. Where two figures are shown in the same column, the figure outside () is at rated voltage and inside () is at the minimum permissible solenoid voltage.



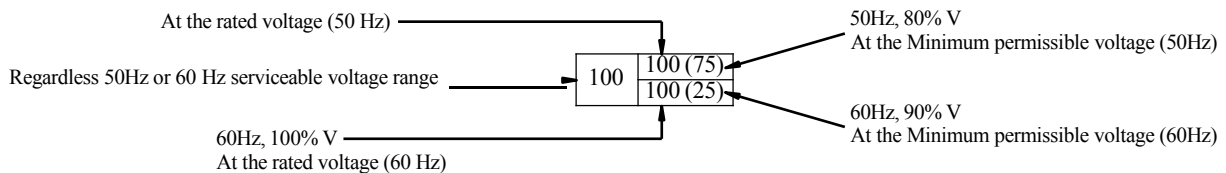







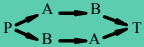
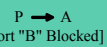
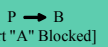





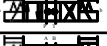

(Example)

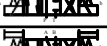

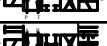
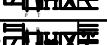
- 2. For the maximum flow between P and T of those valves marked *, refer to page 349.

List of Standard models and Maximum Flow

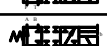
- Models with DC Solenoids : DSG-03-***-D**
- Models with R Type Solenoids : DSG-03-***-R**

No. of Valve Positions Spool-Spring Arrangements	Model Numbers	Graphic Symbols	Max. Flow L/min												
															
			100 Kg/f/cm ²	160 Kg/f/cm ²	250 Kg/f/cm ²	315 Kg/f/cm ²	100 Kg/f/cm ²	160 Kg/f/cm ²	250 Kg/f/cm ²	315 Kg/f/cm ²	100 Kg/f/cm ²	160 Kg/f/cm ²	250 Kg/f/cm ²	315 Kg/f/cm ²	
Three Positions Spring Centered	DSG-03-3C2		120	120	120	120	120	120	80	55	120	120	80	55	
	DSG-03-3C3*		120	120	120	120	120	120	120	120	120	120	120	120	
	DSG-03-3C4		120	120	120	120	120	120	84	64	120	120	84	64	
	DSG-03-3C40		120	120	120	120	120	120	65	53	120	120	65	53	
	DSG-03-3C5*		50	50	50	50	35	24	21	20	45	45	45	45	
	DSG-03-3C60*		120	120	120	--	120	120	120	--	120	120	120	--	
	DSG-03-3C7		120	120	120	45	120	67	35	35	120	67	35	35	
	DSG-03-3C8		--	--	--	--	120	45	31	31	120	45	31	31	
	DSG-03-3C9		120	120	120	120	100	79	57	57	120	79	57	57	
	DSG-03-3C10		120	120	120	65	120	57	51	51	120	57	51	51	
	DSG-03-3C11		120	120	120	120	100	120	62	51	100	120	62	51	
	DSG-03-3C12		120	120	120	65	120	86	47	40	120	86	47	40	
Two Positions No Spring Detented	DSG-03-2D2		120	120	120	120	45	37	30	28	60	60	40	35	
	DSG-03-2D3		120	120	120	120	45	37	30	28	60	60	40	35	
	DSG-03-2D7		120	120	120	120	45	37	30	28	60	60	40	35	
	DSG-03-2D8		--	--	--	--	60	60	40	35	60	60	45	35	
	Two Positions Spring Offset	DSG-03-2B2		110	110	110	110	68	47	38	38	120	114	75	63
		DSG-03-2B3		100	100	100	100	77	77	77	77	120	83	58	48
		DSG-03-2B8		120	120	120	120	53	33	24	23	120	120	120	120
DSG-03-2B8			--	--	--	--	53	33	24	23	120	120	62	47	

Note:

1. Maximum flow rates and applied current.

- The single column describes maximum flow rates regardless voltage within serviceable range.
- Where two figures are shown in the same row, the upper is at rated voltage and the later is at the minimum permissible solenoid voltage.

(Example)

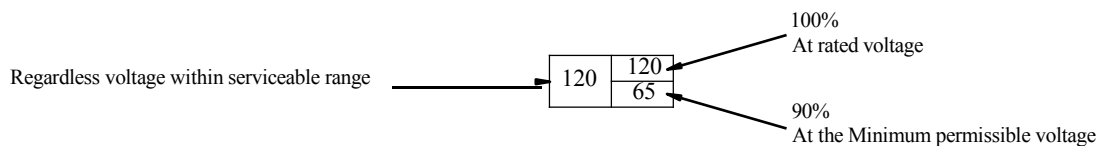

2. For the maximum flow between P and T of those valves marked *, refer to page 349.

List of Spool Function of Shock-Less Type

- Models with DC Solenoids : S-DSG-03-***-D*
- Models with R Type Solenoids : S-DSG-03***-R*

No. of Valve Positions	Spool-Spring Arrangements	Model Numbers	Graphic Symbols	Max. Flow L/min											
				50 Kgf/cm ²	100 Kgf/cm ²	160 Kgf/cm ²	250 Kgf/cm ²	50 Kgf/cm ²	100 Kgf/cm ²	160 Kgf/cm ²	250 Kgf/cm ²	50 Kgf/cm ²	100 Kgf/cm ²	160 Kgf/cm ²	250 Kgf/cm ²
Three Positions	Spring Centered	S-DSG-03-3C2		120	120	120	120	120	120	75	50	120	120	75	50
		S-DSG-03-3C4		120	120	85	65	120	120	75	40	120	120	75	40
Two Positions	Spring Offset	S-DSG-03-2B2		120	100	75	40	39	39	39	39	120	120	105	60
														80	50

Note:

1. Maximum flow rates and applied current.

? The single column describes maximum flow rates regardless voltage within serviceable voltage range.

? Where two figures are shown in the same row, the upper is at rated voltage and the latter is at the minimum permissible solenoid voltage.

(Example)

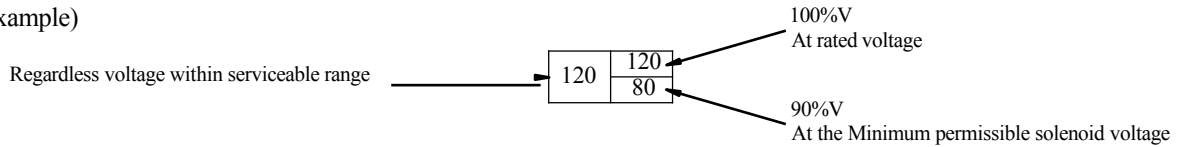

2. For the maximum flow between P and T of those valves marked *, refer to below.

Maximum Flow of center By-Pass

In spool type 3, 5 and 60, P \leftrightarrow T (Center By-Pass) Flow rates are limited as shown in the column below. Described maximum flow rates are regardless voltage within serviceable voltage range.

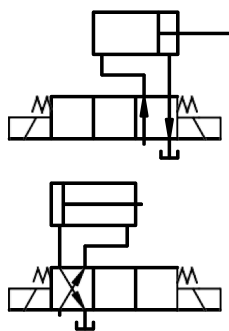

Model Numbers	Graphics Symbols	Max. Flow L/Min.			
		100 Kgf/cm ²	160 Kgf/cm ²	250 Kgf/cm ²	315 Kgf/cm ²
DSG-03-3C3-A *		100	100	100	120
DSG-03-3C3-D**R *		120	120	120	120
DSG-03-3C5-A *		26	21	18	16
DSG-03-3C5-D**R *		35	24	21	20
DSG-03-3C60-A *		84	52	52	?
DSG-03-3C60-D**R *		68	65	61	?
S-DSG-03-3C60-D**R *		50	100	160	?
		120	65	65	?

Typical Changeover Time

Changeover time varies according to oil viscosity, spool type and hydraulic circuit

Standard Type (Without Shockless Function)

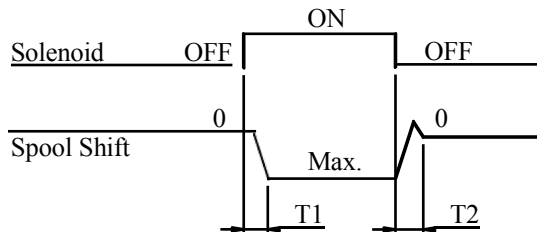

[Test Conditions]

Pressure: 160 Kg/cm²

Flow Rate: 70 L/min.

Viscosity: 30cSt

Voltage : 100%V

(After coil temperature rise and saturates)

[Result of Measurement]

Type	Model Numbers	Changeover Time ms	
		T1	T2
Standard Type	DSG-03-3C2-A※	27	23
	DSG-03-3C2-D※	97	30
	DSG-03-3C2-R※	97	204

Shockless Type

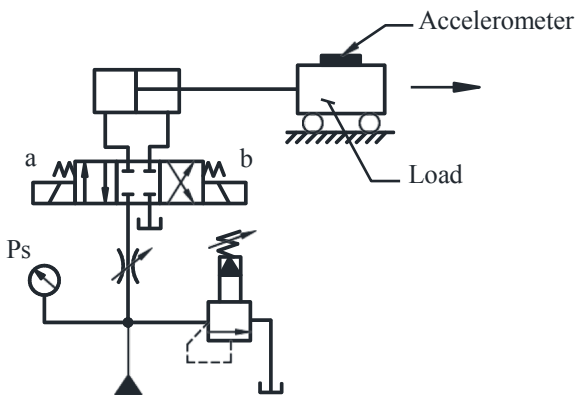

[Test Circuit and Conditions]

Setting Pressure (Ps): 70 Kg/cm²

Load (W): 1000 Kg

Speed : 8.8m/min.

Oil Viscosity : 30 cSt.

[Result of Measurement]

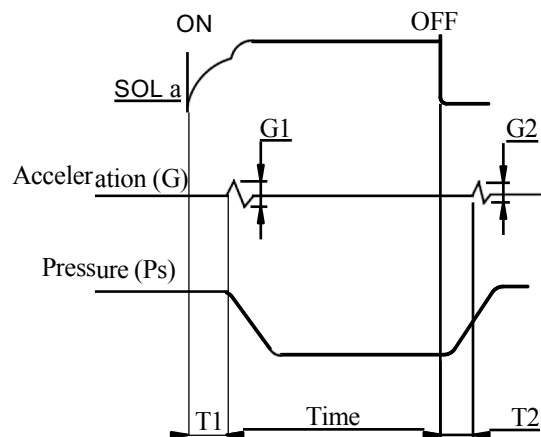

Type	Model Numbers	Time ms		Acceleration (G) m/s ²	
		T1	T2	G1	G2
Shockless Type	S-DSG-03-3C2-D-※	110	120	0.65	0.65
	S-DSG-03-3C2-R-※	110	220		

Spring Offset Valves with Alternate Solenoid (-L)

Though our standard spring offset models use solenoid “b”, alternate models using solenoid “a” are also available. The graphic symbols are expressed below.

For Models 2 B✕A and 2B✕B, refer to table below.

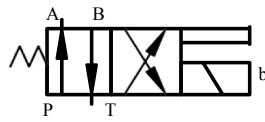
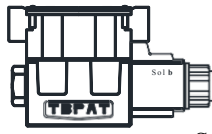

Standard Offset

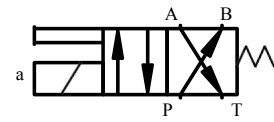
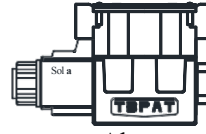

Alternate Offset ('L')

Valves with Center position and One Offset Position (Special Two Position Valve)

In addition to the standard two position valves shown on the table on page 347 and 348 two kinds of valves are available with center position and either one of two offset positions.

Standard and alternate offset types use solenoid “b” and solenoid “a” respectively.

(Example) In case of spool Type “2”

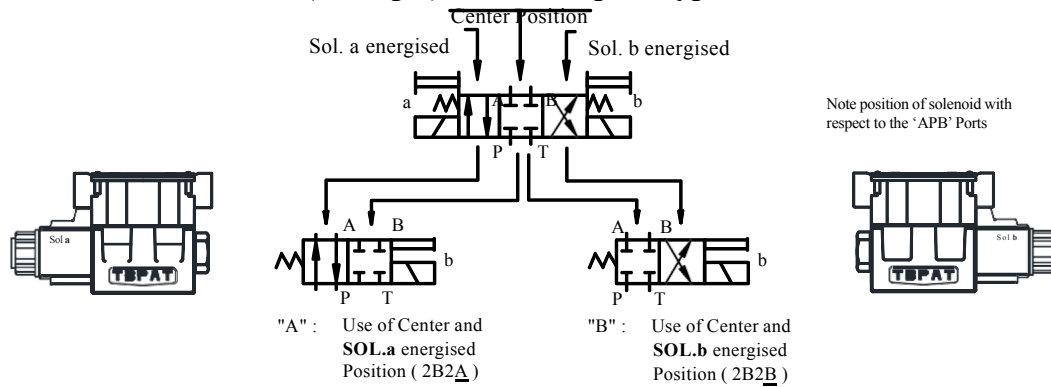

Model Number	Graphic Symbol		Model Number	Graphic Symbol		Model Number	Graphic Symbol
	Standard Offset Type	Alternate Offset Type		Standard Offset Type	Alternate Offset Type		
DSG-03-2D✕A			DSG-03-2D✕A			DSG-03-2D✕A	
(S-)DSG-03-2B2A			(S-)DSG-03-2B2B			DSG-03-2D2A	
DSG-03-2B3A			DSG-03-2B3B			DSG-03-2D3A	
(S-)DSG-03-2B4A			(S-)DSG-03-2B4B			DSG-03-2D4A	
(S-)DSG-03-2B40A			(S-)DSG-03-2B40B			DSG-03-2D40A	
DSG-03-2B5A			DSG-03-2B5B			DSG-03-2D5A	
(S-)DSG-03-2B60A			(S-)DSG-03-2B60B			DSG-03-2D7A	
DSG-03-2B7A			DSG-03-2B7B			DSG-03-2D9A	
DSG-03-2B8A			DSG-03-2B8B			DSG-03-2D10A	
DSG-03-2B9A			DSG-03-2B9B			DSG-03-2D11A	
(S-)DSG-03-2B10A			(S-)DSG-03-2B10B			DSG-03-2D12A	
DSG-03-2B11A			DSG-03-2B11B				
(S-)DSG-03-2B12A			(S-)DSG-03-2B12B				

Pressure Drop

Pressure drop based on viscosity of 35 cSt and specific gravity of 0.850

- Standard type : DSG-03

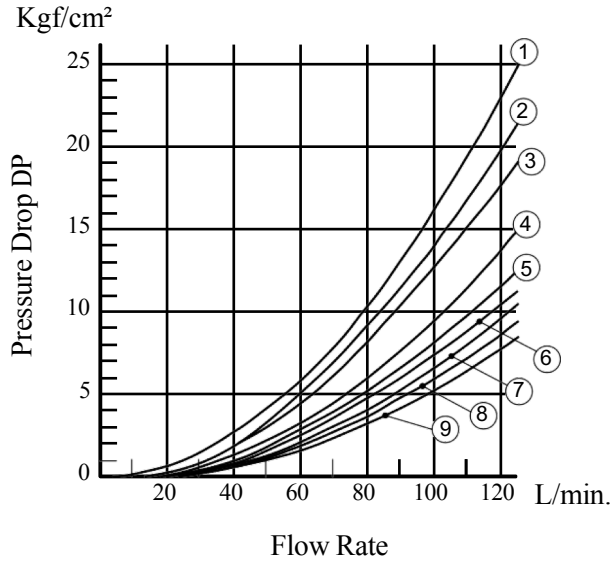

DSG-03-3C2	①	⑦	⑦	⑦	—
DSG-03-3C3	②	⑧	⑧	⑧	⑤
DSG-03-3C4	③	⑨	⑨	⑨	—
DSG-03-3C40	④	⑩	⑩	⑩	—
DSG-03-3C5	⑤	⑪	⑪	⑪	①
DSG-03-3C60	⑥	⑫	⑫	⑫	①
DSG-03-3C7	⑦	—	⑬	—	—
DSG-03-3C8	⑧	—	⑭	—	—
DSG-03-3C9	⑨	⑬	⑭	⑮	—
DSG-03-3C10	⑩	⑭	⑮	⑯	—
DSG-03-3C11	⑪	⑮	⑯	⑰	—
DSG-03-3C12	⑫	⑯	⑰	⑱	—
DSG-03-2D2	④	③	⑥	⑥	—
DSG-03-2D3	⑥	④	⑦	⑦	—
DSG-03-2D7	①	①	②	②	—
DSG-03-2D8	⑥	—	③	—	—
DSG-03-2B2	②	①	⑦	⑦	—
DSG-03-2B3	⑥	②	⑧	⑧	—
DSG-03-2B8	⑥	—	③	—	—

- Shock-Less Type : S-DSG-03

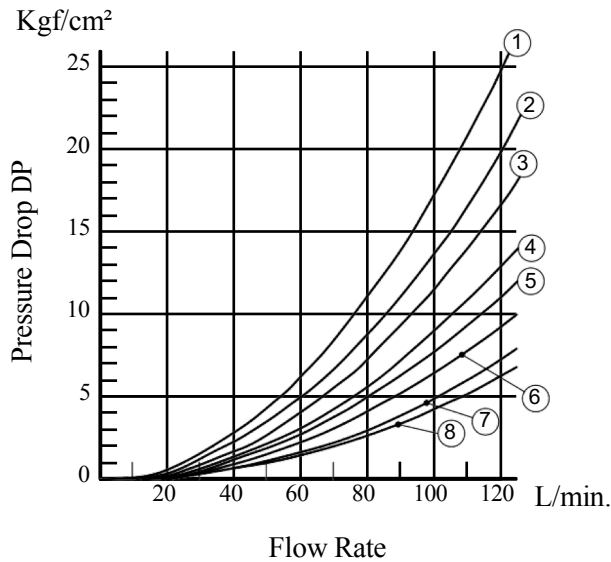

S-DSG-03-3C2	①	⑦	⑦	⑦	①
S-DSG-03-3C4	②	⑧	⑧	⑧	①
S-DSG-03-3C40	④	⑩	⑩	⑩	—
S-DSG-03-3C60	⑥	⑫	⑫	⑫	①
S-DSG-03-3C10	⑩	⑭	⑭	⑭	—
S-DSG-03-3C12	⑫	⑯	⑯	⑯	—
S-DSG-03-2D2	②	③	⑥	⑥	—
S-DSG-03-2B2	①	②	③	③	—

For any other viscosity, multiply by the table below.

Viscosity	cSt	15	2	30	40	50	60	70	80	90	100
Factor		0.81	0.87	0.96	1.03	1.09	1.14	1.19	1.23	1.27	1.30

For any other specific gravity (G'), the pressure drop (DP') may be obtained from the formula below.

$$DP' = DP(G' / 0.850)$$

Terminal Box Type

Models with AC Solenoids: DSG-03-***-A-50

- Double Solenoid: Spring Centred & No-Spring Detented

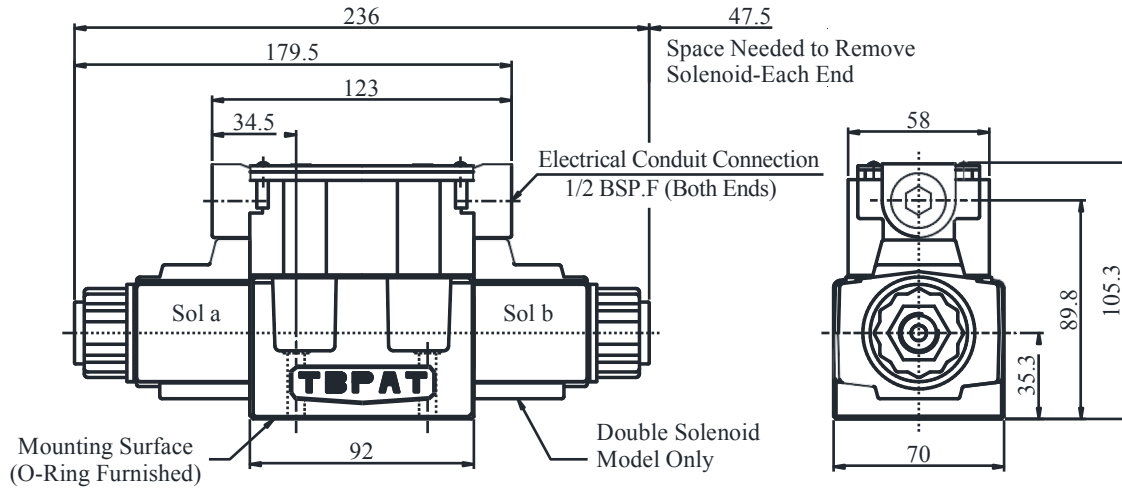

DIMENSIONS IN
MILLIMETRES

- Single Solenoid: Spring Offset

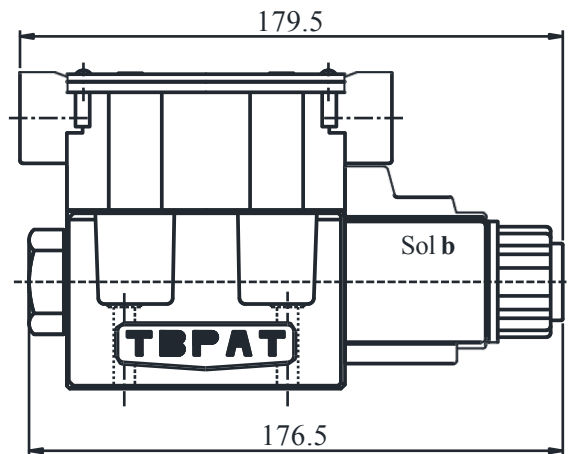

* Solenoid being mounted in the reverse position - SOL **a** side - is also available.

Models with DC Solenoids: (S-) DSG-03-***-D-50

Models with R Solenoids: (S-) DSG-03-***-R-50

- Double Solenoid: Spring Centred & No-Spring Detented

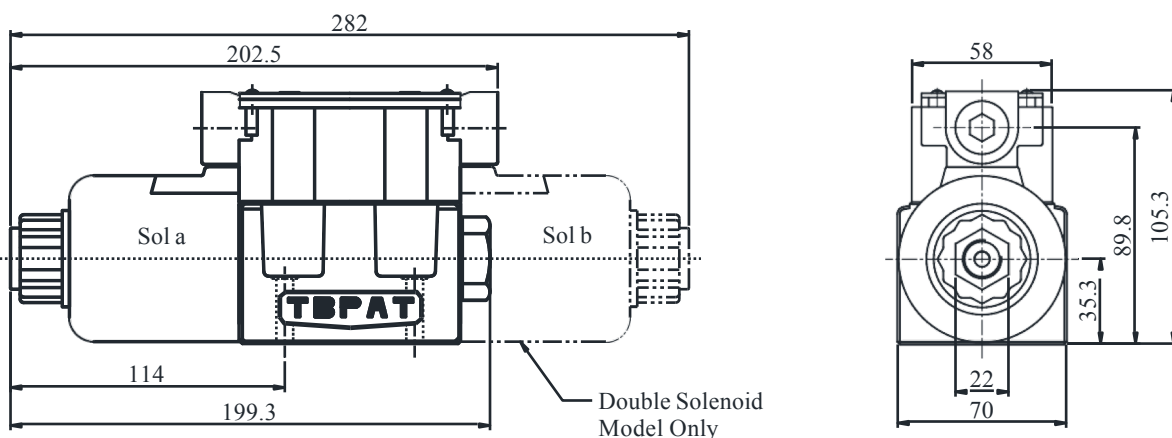

PLUG-IN CONNECTOR TYPE (N) PLUG-IN CONNECTOR WITH INDICATOR LIGHT (N1)

Models with AC Solenoids: DSG-03-~~XXXX~~-A~~X~~-N-50 N1

Cable Departure
Cable Applicable:
Outside Dia. 8 - 10 mm
Conductor Area Not Exceeding 1.5 mm²

Three position of cable departure are available by loosening "Lock Nut" as shown. After location, tighten "Lock Nut" with torque not exceeding 1.05Kgf-m

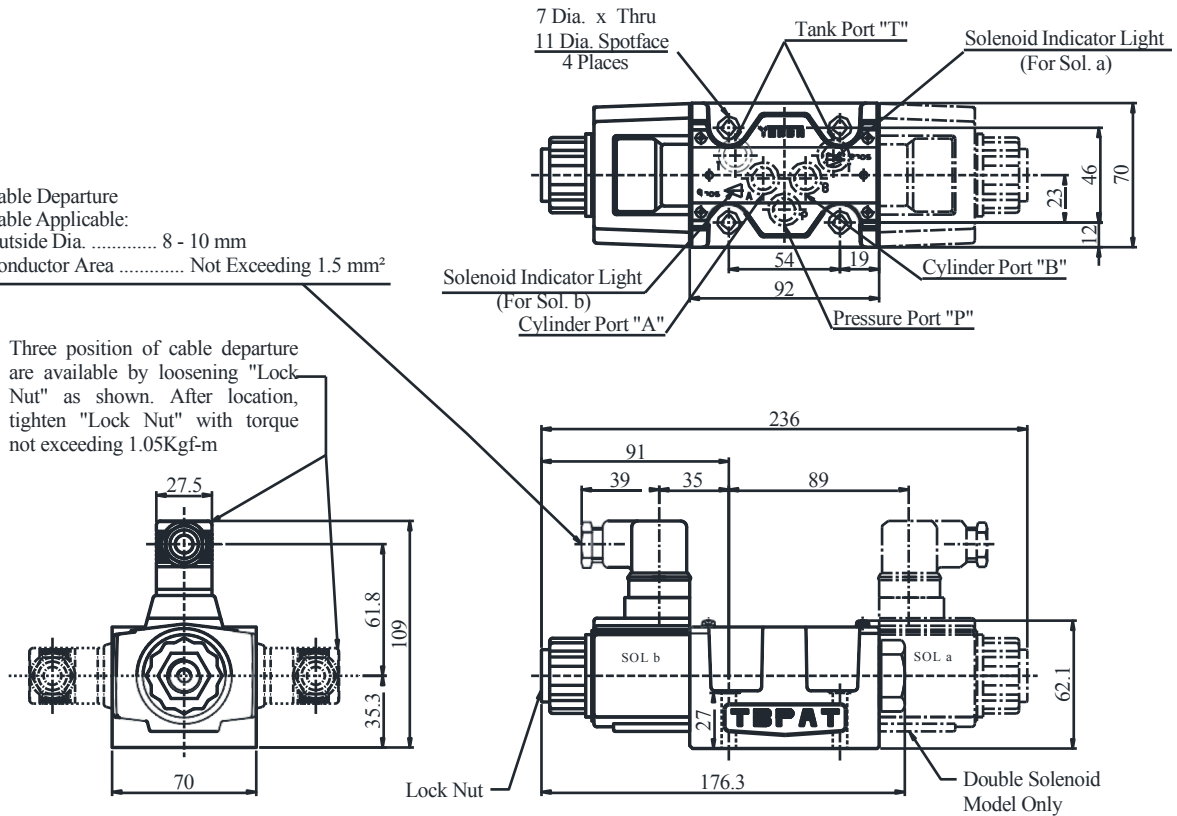

DIMENSIONS IN
MILLIMETRES

Models with DC Solenoids: (S-) DSG-03-~~XXXX~~-D~~X~~-N-50 N1

Models with R Solenoids: (S-) DSG-03-~~XXXX~~-R~~X~~-N-50

Three position of cable departure are available by loosening "Lock Nut" as shown. After location, tighten "Lock Nut" with torque not exceeding 1.05Kgf-m

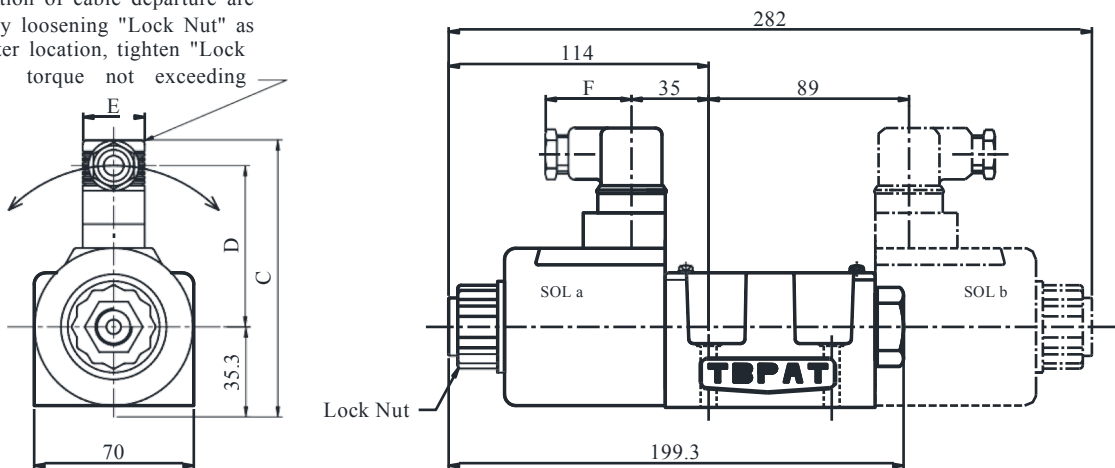

Model number	Dimensions mm			
	C	D	E	F
DSG-03- XXXX -D X -N-50 N1	121.1	73.8	27.5	39
DSG-03- XXXX -R X -N-50	124.9	62.6	34	53

Finishing Dimension of Flow Restrictor

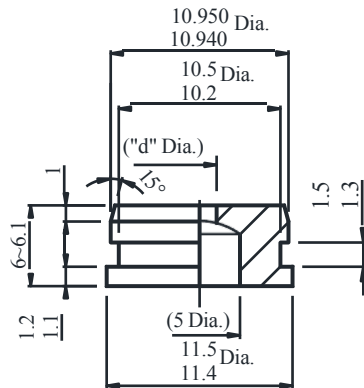

* Orifice dia. "d Dia." should be determined by customer application.

Each port (P,A,B and T) is machined for flow restrictor.

The flow restrictor should be machined in accordance with the above figure, if required.

DIMENSIONS IN
MILLIMETRES

Sub-plate: DSGM-03※-2180

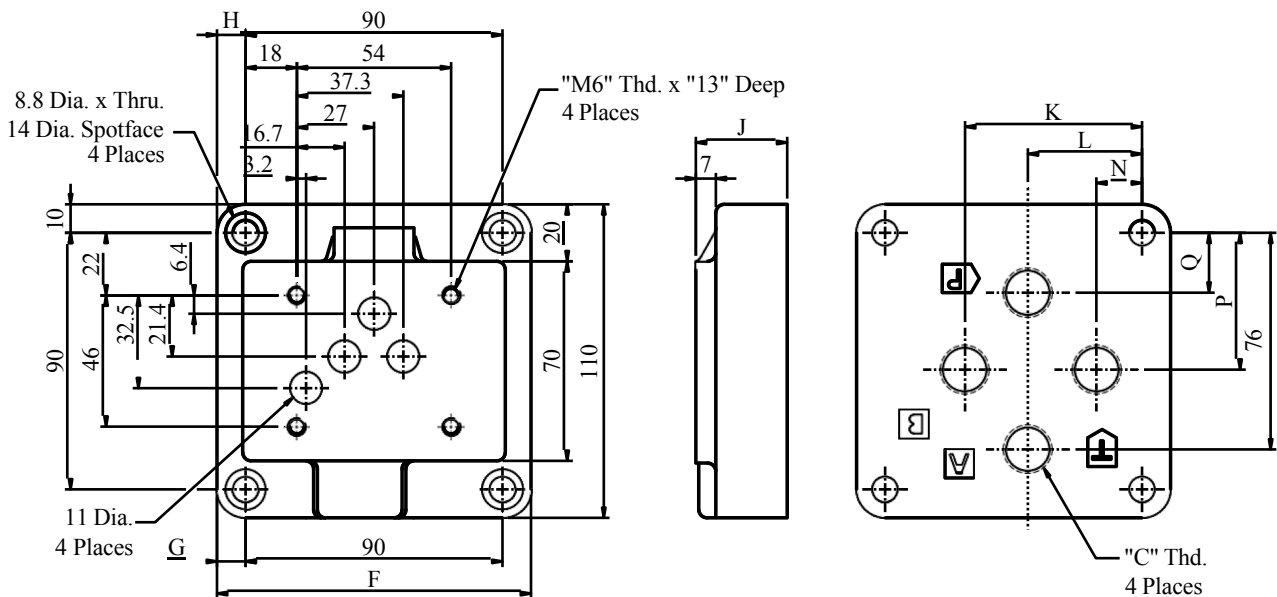

Sub-Plate model Numbers	Piping Size "C" Thd.	Dimension mm								
		F	G	H	J	K	L	N	P	Q
DSGM-03-2180	3/8 BSP.F	110	9	10	32	62	40	16	48	21
DSGM-03X-2180	1/2 BSP.F	110	9	10	32	62	40	16	48	21
DSGM-03Y-2180	3/4 BSP.F	120	14	15	50	80	45	10	47	16

Spare Parts List

List of Seals

Model Numbers	O-Ring Details For Seal Kit	Qty.		
		3C※	2D※	2B※
DSG-03-※※※-※※-50	AS 568 A014	5	5	
	SO-NB-P21	2	2	
	SO-NA-P4	4	2	
DSG-03-※※※-※※-50-N-50	AS 568 A014	5	5	
	SO-NB-P21	2	2	

List of Seal kits

Valve Model Numbers	Seal Kit Numbers
DSG-03-※※※-※※-50	KS-DSG-03-50
DSG-03-※※※-※※-50-N-50	KS-DSG-03-N-50

Note:

When ordering the seals, please specify the seal kit number as shown above.

Solenoid Assy., Coil, Connector Assy. Number

Valve Model Numbers	Solenoid Assy. Numbers	Coil Numbers	Terminal Box / Connector Assy. Part Numbers	Remarks
DSG-03-※※※-A100-50※	SA3-100-51	C-SA3-100-51	AC-TB3-60- ¹ / ₂ ^{*1}	Terminal Box Type
DSG-03-※※※-A120-50※	SA3-120-51	C-SA3-120-51		
DSG-03-※※※-A200-50※	SA3-200-51	C-SA3-200-51		
DSG-03-※※※-A240-50※	SA3-240-51	C-SA3-240-51		
DSG-03-※※※-D12-50※	SD3-12-51	C-SD3-12-51	DC-TB3-60- ¹ / ₂ ^{*1}	
DSG-03-※※※-D24-50※	SD3-24-51	C-SD3-24-51		
DSG-03-※※※-D100-50※	SD3-100-51	C-SD3-100-51		
DSG-03-※※※-R100-50※	SR3-100-51	C-SR3-100-51	R-TB3-60- ¹ / ₂ ^{*1}	
DSG-03-※※※-R200-50※	SR3-200-51	C-SR3-200-51		
S-DSG-03-※※※-D12-50※	SD3-12-S-51	C-SD3-12-51	DC-TB3-60- ¹ / ₂ ^{*1}	
S-DSG-03-※※※-D24-50※	SD3-24-S-51	C-SD3-24-51		
S-DSG-03-※※※-D100-50※	SD3-100-S-51	C-SD3-100-51		
S-DSG-03-※※※-R100-50※	SR3-100-S-51	C-SR3-100-51	R-TB3-60- ¹ / ₂ ^{*1}	
S-DSG-03-※※※-R200-50※	SR3-200-S-51	C-SR3-200-51		
DSG-03-※※※-A100-N1-50※	SA3-100-N1-51	C-SA3-100-N1-51	A100-HD-211/SL	Plug-in Connector with Indicator Light.
DSG-03-※※※-A120-N1-50※	SA3-120-N1-51	C-SA3-120-N1-51	A120-HD-211/SL	
DSG-03-※※※-A200-N1-50※	SA3-200-N1-51	C-SA3-200-N1-51	A200-HD-211/SL	
DSG-03-※※※-A240-N1-50※	SA3-240-N1-51	C-SA3-240-N1-51	A240-HD-211/SL	
DSG-03-※※※-D12-N1-50※	SD3-12-N1-51	C-SD3-12-N1-51	D12-HD-211/SL	
DSG-03-※※※-D24-N1-50※	SD3-24-N1-51	C-SD3-24-N1-51	D24-HD-211/SL	
DSG-03-※※※-D100-N1-50※	SD3-100-N1-51	C-SD3-100-N1-51	D100-HD-211/SL	
S-DSG-03-※※※-D12-N1-50※	SD3-12-S-N1-51	C-SD3-12-N1-51	D12-HD-211/SL	
S-DSG-03-※※※-D24-N1-50※	SD3-24-S-N1-51	C-SD3-24-N1-51	D24-HD-211/SL	
S-DSG-03-※※※-D100-N1-50※	SD3-100-S-N1-51	C-SD3-100-N1-51	D100-HD-211/SL	

Note:

The connector or terminal box assembly is not included in the solenoid assembly.

*1 For '2B' models, use ※-TB3-60-1.

For '3C', '2D' & '2N' models, use ※-TB3-60-2.

Ironcore Assy. Number

N-	DSG	-IC	-03	-AC	-50
Type	Series Number	Iron Core	Valve Size	Coil Type	Design Number
N : Standard Type	DSG : Sol. Operated DC Valve	IC : Iron-Core Assembly	03	AC	50
S : Shock-Less Type				DC (R)	

* 'DC' Iron cores are common for 'R' type models.