

■ Cam Operated Directional Valves

These valves may be used to shift the direction of oil flow by depressing the spool by way of a cam.

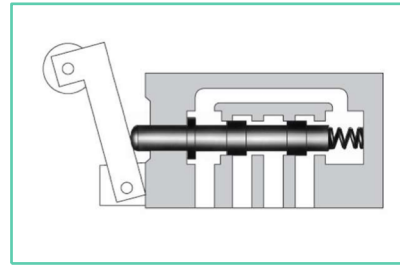



■ Specifications

Model Numbers	Max. Flow L/min	Max. Operating Pressure Kgf/cm ²	Max. T-line Pressure Kgf/cm ²	Mass Kg
DCG-01-2B※-40	30	210	70	1.1
DCG-03-2B※-50	100	250	100	3.8

- Max. flow indicates the ceiling flow which does not affect the normal function (changeover) of valves.

■ Model Number Designation

F-	DC	G	-01	-2	B	2	-R	-40
Special Seals**	Series Number	Type of Connection	Valve Size	No. of Valve Positions	Spool-Spring Arrangement	Spool Type	Roller Position	Design Number
F: Special Seals for Phosphate Ester Type Fluids (Omit if not required)	DC: Cam Operated Directional Valve	G: Sub-Plate Mounting	01	2	B: Spring Offset	2	<div style="display: flex; justify-content: space-around;"> <div style="text-align: center;"> <p>None (Normal Position)</p>  </div> <div style="text-align: center;"> <p>R</p>  </div> <div style="text-align: center;"> <p>Y (DC※-01 only)</p>  </div> </div> <p style="text-align: center;">Mounting Surface</p>	40
						3		50
			8			50		

** Before ordering the Special Seals, consult YUKEN INDIA LTD.

■ Sub-plates

- Sub-plates are available. Specify Sub-Plate model from the table above. When Sub-plates are not used, the mounting surface should have a good machined finish.
- Sub-plates are sharable with DSG-01 (EIC-E-1001, page – 340) and DSG-03 (EIC-E-1002-0, page – 355). See each pages for dimensional drawings.

■ Mounting Bolts

Socket head – cap screws in the table below are included.

Model Numbers	Socket Head Cap Screw	Qty.	Mounting Bolt Ordering Code
DCG-01	M5 x 45 Lg.	4	BKDSG-01-50
DCG-03	M6 x35 Lg.	4	BKDSG-03-20

Direction of Oil Flow for Roller position

Model Numbers	Graphic Symbols	Roller Position and Direction of Oil Flow	
		Extend (Offset)	Depressed
DCG-01-2B2			
DCG-01-2B3			
DCG-01-2B8			
DCG-03-2B2			
DCG-03-2B3			
DCG-03-2B8			

Instructions

- Valve Type “2B8”**
Tank port “T” functions as a drain port. Directly connect it to the reservoir. [Max. allowable back pressure 3.5 Kgf/cm²]

- Actuation force**

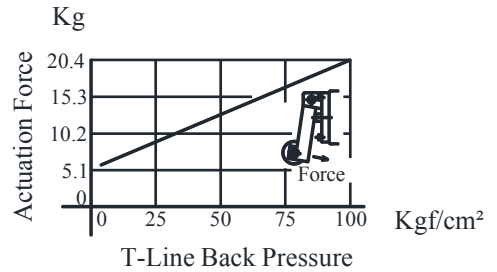

Pressure Drop

- DCG-01**

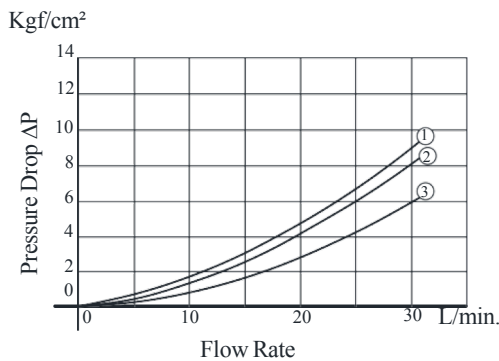

- For any viscosity, multiply the factors in the table below.

Viscosity	cSt	15	20	30	40	50	60	70	80	90	100
Factor		0.81	0.87	0.96	1.03	1.09	1.14	1.19	1.23	1.27	1.30

- For any other specific gravity (G'), the pressure drop ($\Delta P'$) may be obtained from the formula below
 $\Delta P' = \Delta P (G'/G)$ where, ΔP is the value on the above chart and G is 0.85

- DCG-03**

Same as DSG-03 Series Solenoid Operated Directional Valves (Standard Type). See EIC-E-1002, Page-352.

Model Numbers	Pressure Drop Curve No.			
	P→A	B→T	P→B	A→T
DCG-01-2B2	②	②	③	③
DCG-01-2B3	②	②	③	③
DCG-01-2B8	③	--	③	--

● DCG-01-2B※-※-40

Mounting Surface :ISO 4401-AB-03-4-A

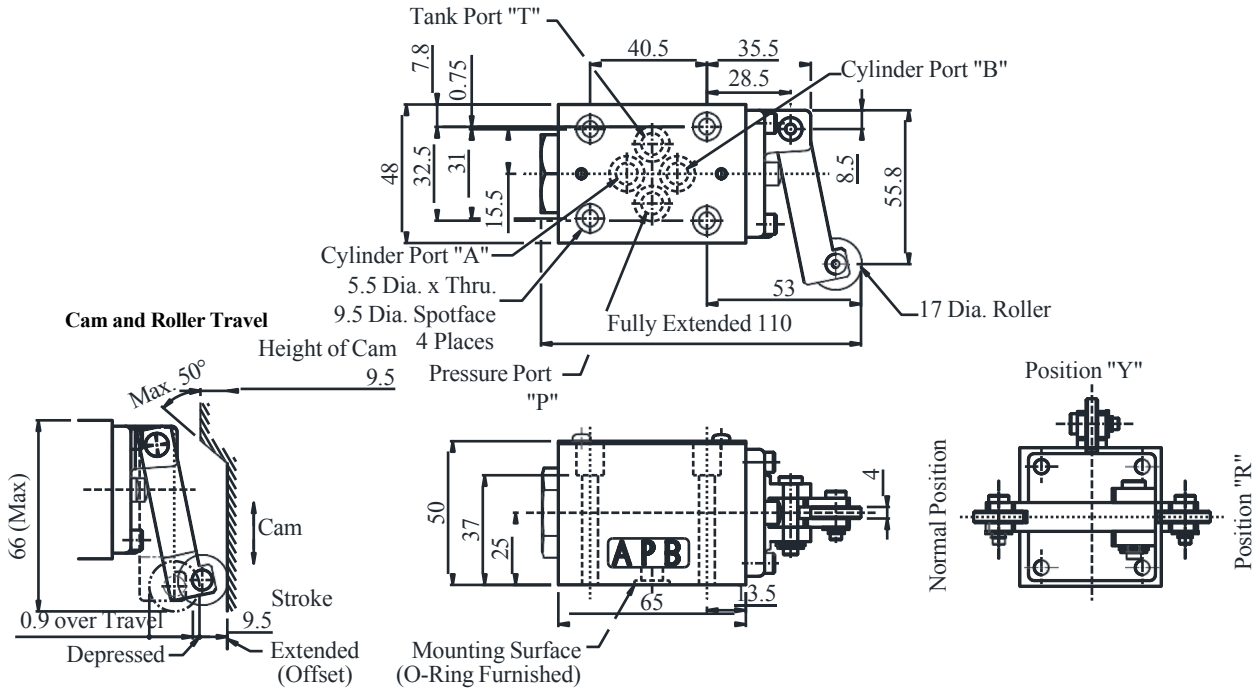

Note :

1. For the valve mounting surface dimensions, see the sub-plate dimensional drawing for DSG-01 Series Solenoid Operated Directional Control Valve.

● DCG-03-2B※-※-50

Mounting Surface :ISO 4401-AC-05-4-A

Finishing Dimensions of Flow Restrictor

* Orifice dia. "d" should be determined by customer application.

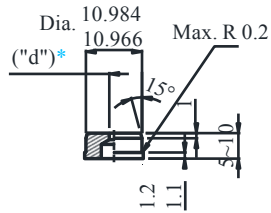

Cam and Roller Travel

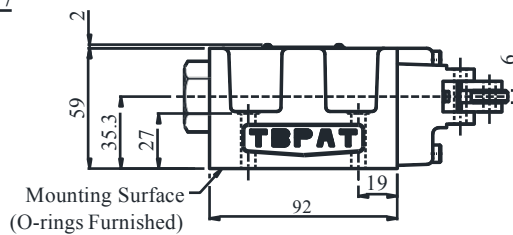
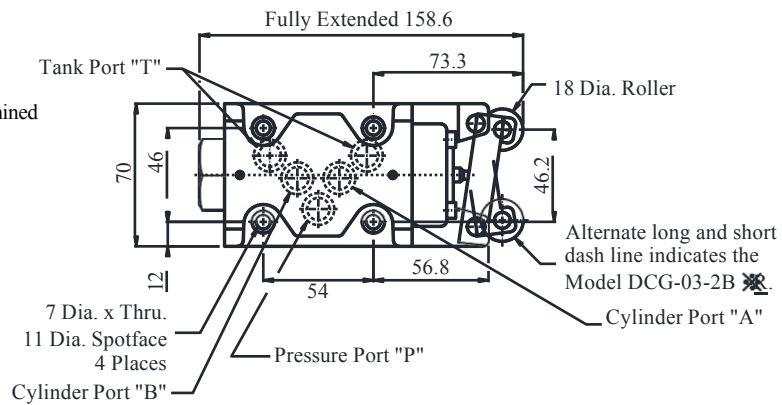
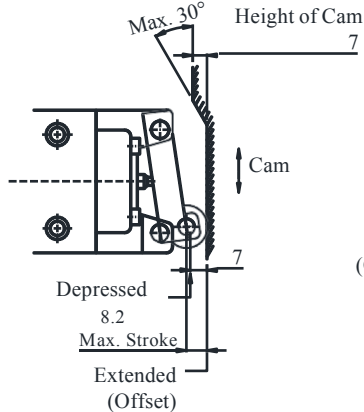

1. Each port (P,A,B and T) is machined for flow restrictor. The flow restrictor should be machined in accordance with the Finishing Dimensions for Flow Restrictor as shown in the right-hand drawing.
2. Although the tank port is shown on the left in our sub-plate, either may be used.

Notes :

1. For the valve mounting surface dimensions, see the sub-plate dimensional drawing for DSG-03 Series Solenoid Operated Directional Valves.

Cam Operated Directional Valves

■ Spare Parts List

● List of Seals

Sl. No.	Name of Part	Part No.	Qty.	
			DCG-01	DCG-03
1	O-Ring	SO-NA-P5	1	-
2	O-Ring	SO-NB-P9	4	-
3	O-Ring	SO-NB-P18	2	-
4	O-Ring	SO-NB-P21	-	2
5	O-Ring	SO-NA-P6	-	1
6	O-Ring	AS568-A014	-	5
7	Back up Ring	SO-BE-P6	-	1
8	Packing	VK4-12280-0	1	-

Note :

When ordering the seals, please specify the seal kit number from the table right.

● List of Seal Kits

Model Numbers	Seal Kit Numbers
DCG-01	KS-DCG-01-40
DCG-03	KS-DCG-03-50